



TECHNICAL AND OPERATIONAL GUIDANCE (TECHOP)

TECHOP (D-07 - Rev1 - Jan21)

A METHOD FOR PROVING THE FAULT RIDE-THROUGH CAPABILITY OF DP VESSELS WITH HV POWER PLANT

JANUARY 2021

DISCLAIMER AND LIMITATION OF LIABILITY

The information presented in this publication of the Dynamic Positioning Committee of the Marine Technology Society (“DP Committee”) is made available for general information purposes without charge. The DP Committee does not warrant the accuracy, completeness, or usefulness of this information. Any reliance you place on this publication is strictly at your own risk. We disclaim all liability and responsibility arising from any reliance placed on this publication by you or anyone who may be informed of its contents.

IN NO EVENT WILL THE DP COMMITTEE AND/OR THE MARINE TECHNOLOGY SOCIETY, THEIR AFFILIATES, LICENSORS, SERVICE PROVIDERS, EMPLOYEES, VOLUNTEERS, AGENTS, OFFICERS, OR DIRECTORS BE LIABLE FOR DAMAGES OF ANY KIND UNDER ANY LEGAL THEORY, ARISING OUT OF OR IN CONNECTION WITH YOUR USE OF THE INFORMATION IN THIS PUBLICATION, INCLUDING BUT NOT LIMITED TO, PERSONAL INJURY, PAIN AND SUFFERING, EMOTIONAL DISTRESS, LOSS OF REVENUE, LOSS OF PROFITS, LOSS OF BUSINESS OR ANTICIPATED SAVINGS, LOSS OF USE, LOSS OF GOODWILL, LOSS OF DATA, AND WHETHER CAUSED BY TORT (INCLUDING NEGLIGENCE), BREACH OF CONTRACT OR OTHERWISE, EVEN IF FORESEEABLE.

THE FOREGOING DOES NOT AFFECT ANY LIABILITY WHICH CANNOT BE EXCLUDED OR LIMITED UNDER APPLICABLE LAW.

SUMMARY

This MTS TECHOP provides general guidance on the need for short circuit and earth fault ride through capability in DP power systems and on methods for proving this capability in certain types of HV power plant. It is intended to provide general background information for vessel owners, class surveyors, power system vendors and shipyards who may become involved in the process of proving fault ride through capability of HV power plant on DP vessels.

Information is provided on the mathematical modelling that should accompany the test results and the preparatory work that should be carried out to build confidence that a successful test outcome will be achieved. The need for a full and sufficient risk assessment of the process is discussed and suggestions are given on formats for recording results and presenting them to class. Although the test method is primarily aimed at newbuild MODUs and large construction vessels which have been specifically built to undergo this type of testing it should be possible to apply the methods described in the TECHOP to some older vessels when adequate care and attention is given to surveying the plant and proving its suitability for testing.

Since the draft revision was published, fault ride through testing as described in this TECHOP is being practiced more widely with shipyards, in Korea, China and Singapore carrying out this type of testing.

CONTENTS

SECTION	PAGE
1 INTRODUCTION	7
1.1 PREAMBLE	7
1.2 TECHOP NAMING CONVENTION	7
1.3 MTS DP GUIDANCE REVISION METHODOLOGY	7
2 SCOPE AND IMPACT OF THIS TECHOP	8
2.1 PREAMBLE	8
2.2 SCOPE	10
2.3 FOCUS OF THIS TECHOP	10
2.4 IMPACT ON PUBLISHED GUIDANCE	11
2.5 ACKNOWLEDGEMENTS	11
3 CASE FOR ACTION	12
3.1 INDUSTRY RELIANCE ON MULTIPLE BARRIERS	12
3.2 DP EQUIPMENT CLASS	12
3.3 MEANS OF CONTROLLING RISK	13
3.4 INDUSTRY EXPERIENCE	13
3.5 THE INFLUENCE OF DP EQUIPMENT CLASS, CAM & TAM	16
3.6 EQUIVALENT INTEGRITY	16
4 CURRENT REQUIREMENTS AND GUIDANCE	17
4.1 GENERAL	17
4.2 EXAMPLE OF STATUTORY BODIES INFLUENCING DP REQUIREMENTS (EG USCG)	18
5 POWER SYSTEM ATTRIBUTES TO BE VERIFIED	19
5.1 HYBRID APPROACH TO PROVING FAULT RIDE THROUGH	19
5.2 ATTRIBUTES TO BE PROVEN	19
6 EXPERTISE REQUIRED FOR CARRYING OUT FAULT RIDE-THROUGH TESTING	22
6.1 INITIAL WORK	22
6.2 EXPERTISE	22
6.3 QUALIFICATION AND APPROVAL	23
6.4 ROLES AND RESPONSIBILITIES	23
6.5 ACTION IN THE EVENT OF AN UNSUCCESSFUL TEST	25
7 INDUSTRY READINESS FOR TESTING	26
7.1 VESSEL CATEGORIES	26
7.2 PURPOSE OF TESTING	27
7.3 CONCERNS TO BE ADDRESSED WHILE EXECUTING FAULT RIDE-THROUGH TESTING	28
8 PRACTICAL CONSIDERATIONS FOR CARRYING OUT TESTING	31
8.1 INTRODUCTION	31
8.2 ESTIMATING SHORT CIRCUIT CURRENTS	31
8.3 PREPARING FOR THE TEST	35
8.4 PREPARATORY ANALYSIS	35
8.5 PREPARATORY TESTING	36

8.6	FAULT RIDE-THROUGH TEST	37
8.7	EARTH FAULT RIDE-THROUGH TEST	45
8.8	THRUSTER DRIVES	48
8.9	MEASUREMENT POINTS	49
8.10	INSPECTIONS AFTER TEST	50
8.11	REQUIRED PROTECTIONS AND PRECAUTIONS	51
8.12	RISK ASSESSMENT	51
9	OBJECTIVES OF POWER PLANT MODEL AND VALIDATION	53
9.1	ANALYSIS AND INITIAL SIMULATION WORK	53
9.2	PRESENTATION OF RESULTS	54
10	ALTERNATIVE FORMS OF TESTING	55
10.1	THE NEED FOR ALTERNATIVE METHODS	55
10.2	LOW VOLTAGE POWER SYSTEMS	55
10.3	VESSELS IN SERVICE	56
11	CONCLUSIONS AND SUGGESTED IMPLEMENTATION STRATEGY	58
11.1	GENERAL CONCLUSIONS	58
11.2	SUGGESTED IMPLEMENTATION STRATEGY	58
12	REFERENCES	60
FIGURES		
Figure 8-1	Sub Transient	33
Figure 8-2	Transient	33
Figure 8-3	Synchronous	34
Figure 8-4	Aperiodic or dc Component	34
Figure 8-5	Short Circuit Current Waveform	34
Figure 8-6	Arrangement of Fault Ride-Through Test	39
Figure 8-7	Measured Short Circuit Current at Feeder to Test Fault	41
Figure 8-8	Bus Voltage Before, During and After Application of Test Fault	41
Figure 8-9	Fault Current, Bus Voltage and Status for Bustie Circuit Breaker and Feeder Circuit Breaker	42
Figure 8-10	Generator Current During Fault and Recovery	43
Figure 8-11	Permissible Operating Cycles	44
Figure 8-12	Arrangement for Earth Fault Test	47
Figure 8-13	Bus Voltages Before, During and After Application of Test Earth Fault	48
Figure 8-14	Earth Fault Current, Bustie Status and Bus Voltage	48
TABLES		
Table 6-1	Roles and Responsibilities	24
Table 8-1	Switchboard Ratings	40
EXTRACTS		
Extract 4-1	USCG Marine Safety Alert	18
Extract 7-1	IMO Requirement for Equal Integrity	26

ABBREVIATIONS

ACBs	Air Circuit Breakers
BNC	Bayonet Neill–Concelman or Baby N Connector
BOP	Blow Out Preventer
CAM	Critical Activity Mode
CCTV	Closed-circuit television
CTs	Current Transformers
EF	Earth Fault
EHS	Enhanced System
ESD	Emergency Shut Down
F&G	Fire & Gas
FAT	Factory Acceptance Test
FMEA	Failure Modes Effects Analysis
GOOSE	Generic Object Oriented Substation Events
GPS	Global Positioning System
HEMP	Hazard Effects Management Processes
HIL	Hardware-In-the Loop
HV	High Voltage
IEC	International Electro Technical Commission
LV	Low Voltage
MV	Medium Voltage
NEMA	National Electrical Manufacturers Association
NMA	Norwegian Maritime Authority
NPD	Norwegian Petroleum Directorate
OEM	Original Equipment Manufacturer
PPE	Personal Protective Equipment
RTDS	Real Time Digital Simulation
SC	Short Circuit
TAM	Task Appropriate Mode
THD	Total Harmonic Distortion
UPS	Uninterruptible Power Supply
USCG	United States Coast Guard
VTs	Voltage Transformers

1 INTRODUCTION

1.1 PREAMBLE

1.1.1 The guidance documents on DP (Design and Operations and People) were published by the MTS DP Technical Committee in 2011, 2010 and 2012, respectively. Subsequent engagement has occurred with:

- Classification Societies (DNV, ABS)
- United States Coast Guard (USCG)
- Marine Safety Forum (MSF)
- Oil Companies International Marine Forum (OCIMF)

1.1.2 Feedback has also been received through the comments section provided in the MTS DP Technical Committee Web Site.

1.1.3 It became apparent that a mechanism needed to be developed and implemented to address the following in a pragmatic manner.

- Feedback provided by the various stakeholders.
- Additional information and guidance that the MTS DP Technical Committee wished to provide and a means to facilitate revisions to the documents and communication of the same to the various stakeholders.

1.1.4 The use of Technical and Operations Guidance Notes (TECHOP) was deemed to be a suitable vehicle to address the above. These TECHOP Notes will be in the following categories:

- General TECHOP (G)
- Design TECHOP (D)
- Operations TECHOP (O)
- People TECHOP (P)

1.2 TECHOP NAMING CONVENTION

1.2.1 The naming convention, TECHOP (CATEGORY (G / D / O / P) – Seq. No. – Rev.No. – MonthYear) TITLE will be used to identify TECHOPs as shown in the examples below:

Examples:

- TECHOP (D-01 - Rev1 - Jan21) Addressing C³EI² to Eliminate Single Point Failures
- TECHOP (G-02 - Rev1 - Jan21) Power Plant Common Cause Failures
- TECHOP (O-01 - Rev1 - Jan21) DP Operations Manual

Note: Each Category will have its own sequential number series.

1.3 MTS DP GUIDANCE REVISION METHODOLOGY

1.3.1 TECHOPs as described above will be published as relevant and appropriate. These TECHOP will be written in a manner that will facilitate them to be used as standalone documents.

1.3.2 Subsequent revisions of the MTS Guidance documents will review the published TECHOPs and incorporate as appropriate.

1.3.3 Communications with stakeholders will be established as appropriate to ensure that they are notified of intended revisions. Stakeholders will be provided with the opportunity to participate in the review process and invited to be part of the review team as appropriate.

2 SCOPE AND IMPACT OF THIS TECHOP

2.1 PREAMBLE

- 2.1.1 This TECHOP provides general high level guidance and is intended to be read by vessel owners, shipyards and those considering providing services in relation to fault ride through testing. Lessons learned from review of loss of position incidents have been summarized within the guidance documents published by the MTS DP Committee (Design, Operations and Development of People and various TECHOPs).
- 2.1.2 One of the key lessons learned was that DP Equipment Class requirements needed to be supplemented with a focus on the Industrial Mission. This focus on the Industrial Mission, brought to light the need to understand the activities being performed as part of the Industrial Mission and the consequences of the loss of position.
- 2.1.3 This understanding led to the development of the concepts of Critical Activity Mode (CAM) and Task Appropriate Mode (TAM) and the understanding that CAM's objectives are to achieve the highest level of station keeping integrity and enhance the predictability of failure consequences.
- 2.1.4 Achieving the highest level of station keeping integrity on DP is influenced by what is referred to in the MTS Guidance documents as the seven pillars:
1. Autonomy.
 2. Independence.
 3. Segregation.
 4. Differentiation.
 5. Fault tolerance.
 6. Fault resistance.
 7. Fault ride through.
- 2.1.5 The guidance documents address these seven pillars, the influence they have, the consideration that is needed in areas of Design, Operations and People and the importance and thoroughness of analysis and the need to prove it by effective testing.
- 2.1.6 A means of achieving the objectives of the Seven Pillars was to operate diesel electric power plants in a default configuration of two or more independent power systems (open busties) and to avoid cross connections of any nature between redundancy groups. Post failure capability governed operating limits and criteria. A consequence of operating in such configurations was a requirement for a larger number of engines on line, usually operating on low loads with a resultant detrimental effect on the vessel's emissions footprint.
- 2.1.7 Emissions footprint reduction aspirations imposed as Permit Requirements is the driving force for seeking alternate configurations and one of these options is the consideration of tying independent power systems together (closed bus operations).
- 2.1.8 When the principles of Autonomy, Independence and Segregation are compromised (as examples, closed busties, cross-connections of any nature between redundant groups, etc.), additional emphasis and focus is required on proving fault tolerance, fault resistance and fault ride through.

- 2.1.9 Learnings gleaned from incidents have led to the conclusion that DP Failure Modes and Effects Analysis (FMEA) proving trials and annual DP trials conducted in line with current practices employed by a significant number of practitioners have been unable to verify or validate fault ride through capability in configurations with closed busties. Current practices need to be supplemented by additional methods to verify/validate and build confidence in fault ride-through capability.
- 2.1.10 Extensive verification by testing is essential to demonstrate and build confidence in fault ride through capability for various failure modes such as short circuits, earth faults and permutations thereof including asymmetric faults and arcing faults.
- 2.1.11 The fault ride through test method described in this TECHOP has been demonstrated successfully and accepted as verification by certain Classification Societies.
- 2.1.12 Pre-requisites to testing are:
- Equipment should be designed and built to facilitate testing or be of a suitable design and construction so as to facilitate safe, effective verification by testing.
 - Activities are completed to verify and validate that all equipment being tested meets Original Equipment Manufacturer (OEM) specifications to carry out such tests.
 - Risk assessments and details of mitigations to be of suitable and sufficient quality to build confidence to test.
 - Where it has been determined that verification by testing will include a fault ride through test, any and all necessary means must be employed to build confidence in successfully achieving the objectives at the first test. This may require testing at different stages using multiple avenues (modelling/simulations/testing) as precursors to the equipment being subjected to the test.
 - Necessary modelling and simulations are carried out. One of the objectives of testing should be to validate the model. Where the test process is to include fault ride-through testing, the degree of confidence in modelling and simulation should be such that only one successful set of live tests (fault ride-through & earth fault) should be needed to validate the model. The validated model can then be used to prove fault ride-through capability for other combinations.
 - Fault ride-through testing must be carried out by entities / organizations with the required technical knowledge / knowhow, tools (modelling / simulations / data capture) technical and operational expertise and competent resources.
- 2.1.13 Verification by such testing should be carried out only if adequate confidence can be built that it can be carried out safely. This confidence should be substantiated with all supporting documentation containing appropriate levels of detail.
- 2.1.14 It is emphasized that this TECHOP provides guidance on one method of testing to demonstrate and build confidence in fault ride through capability of HV power systems operated with their bus ties closed. It is not intended to negate any ongoing or future efforts seeking alternate credible means of demonstrating fault ride through capabilities.
- 2.1.15 The suitability/acceptability of a DP vessel to undertake its Industrial Mission is determined by a multitude of Stakeholders (e.g., Owners, Classification Societies, Statutory authorities, Charterer's etc.). Nothing in this TECHOP is intended to exclude or endorse decisions on the suitability of a vessel.
- 2.1.16 It is emphasized that Classification Societies stipulate requirements to be met in order to be granted Class Notations. Other Stakeholders may impose additional requirements (e.g. Contractual, Statutory). Verification requirements of all such stakeholders must be unambiguously understood in order to meet desired expectations of station keeping integrity.

- 2.1.17 This TECHOP addresses a method of proving fault ride through capability of HV power systems commonly found on DP MODUs and larger construction vessels. It is acknowledged that this method may not be suitable for all types of power plants/HV power plants. It is acknowledged that the wide variability of power plants may preclude one common test method. However, the goal of demonstrating fault ride through capability should be common. It is expected that the DP Community will develop effective and credible ways of building confidence and demonstrating fault ride through capability through acceptable verification by testing.
- 2.1.18 Verification by testing, as discussed in this TECHOP, is part of a process of analysis and testing intended to build confidence in the station keeping integrity of HV power plants operating with closed busties, by demonstrating fault ride-through capability. The level of confidence achieved should address all stakeholder concerns related to undertaking CAM operations with the power plant configured as a common power system (open / closed bus, CAM / TAM operations - decisions to be agreed to by all stakeholders). Vessels that have not carried out sufficient verification by testing (either by this method or alternate credible and accepted methods), due to a lack of confidence that it can be carried out safely in controlled conditions, should continue in their efforts to demonstrate fault ride through capability and undertake CAM operations in configurations that can be supported by objective documented evidence with the approval of appropriate identified and accountable stakeholders.
- 2.1.19 Where fault ride through testing is being considered it would be prudent to perform a formal assessment of the financial risks and benefits.

2.2 SCOPE

2.2.1 This TECHOP provides information on:

- The need for better analysis and testing to prove fault ride through.
- Class and regulatory requirements for testing.
- The objectives of creating a validated power plant model.
- The expertise required to carry out the work.
- DP industry preparedness.
- The practicalities of testing.
- Alternative methods of proving fault ride-through.

2.3 FOCUS OF THIS TECHOP

2.3.1 The focus of this TECHOP is to address the significance of fault ride through capability.

2.3.2 Fault ride through capability is a significant aspect of proving the fault tolerance of a DP system power plant. Its significance is further increased when the principles of independence and segregation in power plants are not adhered to as the lack of fault ride through capability can lead to a loss of position.

2.3.3 It is acknowledged that a loss of position can manifest itself through the occurrence of other failure modes in power plants operating with busties closed, for example:

- Generator fuel control systems failures.
- Generator excitation control systems failures.
- Failures of harmonic cancellation facilities that lead to Total Harmonic Distortion (THD) levels with the potential for resonance or other undesirable effects.
- Load sharing system failures.
- Power Management System failures.
- Switchboard component degradation.

2.3.4 Information on these issues and guidance to address them are covered in other TECHOPs and in the MTS DP Vessel Design Philosophy Guidelines.

2.4 IMPACT ON PUBLISHED GUIDANCE

2.4.1 This TECHOP provides supplementary information to that provided in Section 9.2.5 of the 'MTS DP Vessel Design Philosophy Guidelines', Part II, 2012 but does not alter or invalidate the information provided in that section.

2.5 ACKNOWLEDGEMENTS

2.5.1 The DP Committee of the Marine Technology Society greatly appreciates the contribution of ABB, GE, Siemens and AKA to the preparation of this TECHOP.

3 CASE FOR ACTION

3.1 INDUSTRY RELIANCE ON MULTIPLE BARRIERS

3.1.1 The Oil & Gas industry has a long established philosophy of utilizing multiple barriers as a means to manage the risks associated with activities which may have unacceptable consequences.

3.1.2 As an example, when drilling from Mobile Offshore Drilling Units (MODUs), the barriers to the consequence of a loss of containment may include:

- The weight of drilling mud in the well.
- The ability of the Blow Out Preventer (BOP) to shear the pipe, seal the well and disconnect the riser.
- The redundancy and fault tolerance of the DP system on DP MODUs.

3.1.3 The commonly used 'Swiss Cheese' model demonstrates how safety systems with multiple barriers can be defeated if the limitations or 'holes' in each of the barriers align to allow initiating events to propagate through, leading to an occurrence of the unacceptable event.

3.1.4 Some of these barriers rely on active elements to provide the protection. For these barriers to be effective, they should not be in a failed state when called upon to function as an effective barrier. The greater the reliance on such protective functions as a barrier, the greater is the probability of the barrier being defeated. Detailed analysis proven by effective testing is an essential aspect of enhancing confidence in such barriers.

3.2 DP EQUIPMENT CLASS

3.2.1 IMO MSC 645 'Guidelines for Vessels with Dynamic Positioning Systems' defines three equipment classes; 1, 2 and 3 which are intended to provide varying degrees of station keeping integrity to match the consequence of a loss of position. The highest level of station keeping integrity is associated with DP class 3 vessels. The default power plant configuration for these vessels is two or more independent power systems (busties open). It is accepted that the power plant may be operated as a common system if integrity equal to that provided by independent power systems is achieved in the design. This TECHOP describes part of the process required to achieve equal integrity.

3.2.2 In practice, the DP community and most coastal states accept that a well-designed DP class 2 vessel can also achieve the required level of station keeping integrity for any DP operation when correctly configured. This acceptance stems from the understanding that the frequency of technical failures of active components and the influence of the DP system configuration have a greater effect on station keeping integrity than the frequency of fires and flooding. Thus, there may be justification for carrying out fault ride through testing on vessels of DP classes 2 & 3. The measures associated with enhanced protection against the effects of fire and flooding, as required for the DP Equipment Class 3, notations have not been adequate to address such technical or configuration related failures.

3.2.3 There is no requirement within each DP equipment class to operate the vessel in a configuration that provides the highest level of station keeping integrity, only in a configuration that complies with the requirements of that class. Thus, there are often opportunities to optimise station keeping integrity by adopting a defined configuration when it is necessary to do so.

3.3 MEANS OF CONTROLLING RISK

- 3.3.1 As DP equipment class on its own is not a comprehensive means of addressing the risk associated with loss of position, MTS DP Operations Guidance promotes the use of DP system configurations which address the relative risk. Critical Activity Mode (CAM) is the configuration which provides the highest level of station keeping integrity and is the default operating condition for MODUs and construction vessels. Hazard Effects Management Process are then used to justify the adoption of a Task Appropriate Mode (TAM) that allows greater flexibility to operate the plant more efficiently with reduced fuel consumption, pollution and running hours. CAM configurations typically require the power plant to be configured as two or more independent power systems, which reduces the risk of failure effects in one power system propagating to the other by way of the busties.
- 3.3.2 Configurations for TAM may include operating the power plant as a single common power system in which fault tolerance and therefore DP system redundancy relies heavily on a range of protective functions and power system attributes that can isolate the fault and allow the plant to ride through the failure effects without malfunction. Use of CAM where Hazard Effects Management Processes (HEMP) processes suggest TAM is acceptable can be detrimental in respect of limiting opportunities for inspection, repair and maintenance and may unnecessarily increase fuel consumption, pollution and exposure to non-productive time.
- 3.3.3 Much of the impetus for developing CAM and TAM comes from experience of DP vessels operating with their busties closed which did not have the anticipated degree of fault tolerance. The DP community has worked to address these deficiencies by providing new Class rules, guidance and advanced power plant designs but a legacy of uncertainty remains to be overcome.
- 3.3.4 Further information on CAM and TAM can be found in the MTS DP Operations Guidance and IMCA M220, 'Guidance on Operational Activity Planning'.

3.4 INDUSTRY EXPERIENCE

- 3.4.1 The IMCA Station Keeping Incident Reporting Scheme (1) is a voluntary and the largest record of station keeping incidents. It provides useful information to members but is not a comprehensive record of DP incidents and their causes. To supplement this, information from the consultant community has been included in the discussion below.
- 3.4.2 Experience of DP incidents suggests that many diesel electric DP vessels subjected to short circuit conditions by testing or due to a genuine fault, fail to exhibit the necessary levels of fault tolerance, resulting in failure effects exceeding the worst case failure design intent. Typical failure effects include loss of all thrusters.
- 3.4.3 The following anonymous examples give a brief outline of the DP community's experience of failure effects associated with lack of fault tolerance and ride-through capability in particular. Of the 18 examples, 3 are failed test results and the remaining 15 are failures which occurred on vessels in service:
1. Drillship suffers severe voltage dip conditions associated with maloperation of a generator (stopped generator connected to bus). All thrusters trip, but blackout recovery fails on several thrusters because of software errors in some of the drives.
 2. Pipe layer suffers a short circuit fault in drive transformer due to vibration eroding insulation. All thrusters stop because of inadequate ride-through capability in thruster drives.
 3. Pipe layer suffers short circuit fault inside generator. All thrusters lost to DP because steering hydraulic pumps trip during short circuit.

4. Drillship subject to a short circuit fault in drive transformer. All thrusters stop but restart again because drive manufacturer installed protective functions without consultation with vessel owner or FMEA provider.
5. Crane vessel suffers short circuit fault in one asynchronous thruster motor. Deceleration of all consumers and reacceleration after fault clearance causes generators to trip on over current.
6. Drillship suffers short circuit failure of harmonic filters. All thruster drives trip.
7. Semi-submersible suffers failure of water cooling system within high voltage thruster drive. Short circuit in drive causes voltage dip which causes all thrusters to stop.
8. Semi-submersible suffers short circuit on main bus caused by intrusive maintenance while operating on DP. All thrusters stop, vessel blacks out. Due to numerous flaws in the redundancy concept, it takes days to recover power.
9. Drilling ship suffers earth fault on main distribution. All forward thrusters trip because earth fault protection does not operate as it should despite coordination being correct and relays having no apparent defect.
10. Semisubmersible suffers single phasing fault leading to loss of emergency switchboard. Uninterruptible Power Supply (UPS) supplies changeover to backup but several thrusters stop because of insufficient ride-through in their control supplies.
11. Semi-submersible. Generator suffers internal short circuit fault while connected to main bus. Thruster control supplies have no battery backup. Voltage dip caused by short circuit fault causes all thrusters to stop.
12. Well intervention vessel suffers inadvertent closure of main bustie due to act of maloperation. All generators trip due to poor protection coordination. Emergency Shut Down (ESD) and loss of position occur.
13. Construction vessel suffers arcing in main switchboard when high resistance joint melts insulating boot, reducing clearance, causing flashover.
14. Drillship subject to short circuit fault in thruster drive. Loss of all thrusters because protective functions in drives trip them offline due to the voltage dip.
15. DP class 2 ROV support vessel – Short circuit in generators causes complete blackout.
16. Drill ship. Loss of all thrusters during short circuit testing. Service transformers trip on under voltage before the fault is cleared.
17. Wind farm installation vessel. Short circuit testing carried out by classification society. Loss of thrusters exceeding the worst case failure design intent. Test results prove that the protection scheme does not actually work as intended despite the coordination study being correct and relays being fully functional.
18. Diving vessel operating with busties open experiences inadvertent closure of busties during annual DP trials due to flaws in interlocking system. Power plant becomes unstable and all generators trip.

3.4.4 The information above supports two conclusions in relation to power plant configurations based on closed busties:

- The existing analysis and test methods used during commissioning and DP FMEA proving trials do not adequately ensure a DP vessel's ability to maintain position and heading following a severe power system disturbance.
- Industry's experience of these incidents and consequences of loss of position have cast doubts whether DP vessels operating with closed busties have equivalent station keeping integrity to that of vessels operating in an open bus configuration.

- 3.4.5 Until the development of DP class notations requiring more realistic testing of power plant, the majority of verification was based on static analyses required by main class rules such as short circuit withstand calculations and protection coordination studies. Testing was limited to commissioning activities such as secondary injection tests. Attempts to prove voltage dip ride-through were limited to starting large motors or transformers with only one generator connected to the bus.
- 3.4.6 Rapid and effective blackout recovery systems are often cited as an additional barrier between loss of position and an unacceptable event. These have only recently become a requirement of certain DP notations but have been implemented in DP vessel designs for many years. Unfortunately, this function has proved to be another example of a barrier which was often subjected to insufficient analysis and tested in an unrealistic manner. There are numerous examples of blackout recovery systems recovering the vessel from simulated blackout conditions but failing to recover the plant correctly following a real blackout.
- 3.4.7 Thus, the case for action can be summarised as follows:
- A severe power system disturbance is a reasonably foreseeable event.
 - DP vessels may not have sufficient protection or related power system attributes to maintain station following such a fault.
 - Blackout recovery systems may not provide the additional barrier to loss of position that is expected.
 - There is a need to reduce the frequency of incidents across the whole DP fleet to reduce the demand on other barriers such as emergency disconnect which may also fail to operate leading to unacceptable consequences.
- 3.4.8 The response of DP vessel charterers to this experience has been to promote the use of multiple independent power systems for critical DP activities and even for some less critical activities where confidence in the fault tolerance of the power plant has been low. This lack of confidence is often related to poor documentary evidence to support the analysis and verification of the DP redundancy concept such as DP FMEAs, proving trials, annual trials and operations manuals.
- 3.4.9 This approach could have provided a satisfactory solution for charterers was it not for rising fuel costs and the fact that vessel operators are increasingly challenged to reduce pollution generally and especially when operating in environmentally sensitive locations.
- 3.4.10 Thus, the major classification societies were challenged to improve the analysis and testing regime for DP vessels operating their diesel electric power system with closed busties.

3.5 THE INFLUENCE OF DP EQUIPMENT CLASS, CAM & TAM

- 3.5.1 The original intention of defining three DP equipment classes in IMO MSC 645 'Guidelines for Vessels with Dynamic Positioning Systems' was to provide three classes of DP system to match the consequences of a loss of position. The major difference between the top two classes is that failure criteria for DP class 3 includes passive components and the effects of fire and flooding. In practice, the additional requirements for DP class 3 vessels were not really effective in improving station keeping integrity because the number of DP incidents associated with those additional failure criteria is very small and swamped by those failure causes which the two classes have in common. Very few coastal states ever required DP class 3 vessels exclusively for any activity. The one additional distinction that could have made differences is the requirement in MSC 645 for DP class 3 vessels to operate their power plants with busties open unless a configuration based on closed busties could be proven to have equivalent integrity. This requirement was subject to variable interpretation and DP class 3 vessels are known to operate their power plants with the busties closed. It is also fair to say that greater attention to compliance with the common requirement for fault tolerance in DP Class 2 & 3 would also have reduced the number of DP incidents.
- 3.5.2 DP notations are still structured around the basic requirements of IMO MSC 645 and therefore it is logical for the classification societies to apply the most stringent test and analysis requirement to the equipment class intended to provide the highest level of station keeping integrity. At least two of the major classifications societies have clarified their rules for DP class 3 notations to indicate that additional requirements are to be satisfied for those wishing to carry out DP class 3 operations with the busties closed.

3.6 EQUIVALENT INTEGRITY

- 3.6.1 Attempts to prove equivalent integrity by Quantitative Reliability Analysis (QRA) are fraught with difficulty and may be easily challenged. In determining the point at which equivalent integrity has been reached it should be noted that there are a significant number of DP system failure modes where the configuration of the busties makes no or little difference to the failure effect. These include:
- DP control systems.
 - Power management system.
 - Position references and sensors.
 - Thrusters.
 - ESD & F&G systems.
 - Data communications networks.
 - Certain acts of maloperation.
- 3.6.2 The rules for DP notations that are intended to provide for closed bustie DP power systems of equivalent integrity to those based on open busties depend heavily on duplication of protective functions and testing of such functions to reduce the risk from hidden failures. Part of the process of maintaining the level of station keeping integrity will therefore include periodic validation of the continued effectiveness of these functions through diagnostics and testing.

4 CURRENT REQUIREMENTS AND GUIDANCE

4.1 GENERAL

- 4.1.1 Requirements for DP vessels have traditionally been addressed by reference to guidance provided by several industry bodies (example IMO, IMCA, MTS DP Committee). Rules have been developed by classification societies and requirements to be met to achieve class notations have been stipulated.
- 4.1.2 In some cases, statutory bodies have mandated specific requirements to be complied with (examples USCG, NMA, NPD).
- 4.1.3 Charterers have imposed or emphasised requirements, oftentimes through contractual obligations. Usually, such emphasis has been the result of incidents or hi-potential near misses that have been experienced by industry.
- 4.1.4 Owners are encouraged to clearly understand the requirements of all stakeholders (current and potential) and stipulate such requirements as may be necessary to satisfy all stakeholders. Requirements should be clearly and unambiguously understood and alignment on acceptance criteria achieved between all stakeholders.
- 4.1.5 This TECHOP does not interpret rules of classification societies or other statutory bodies. When referred to it serves only to provide examples of reference.
- 4.1.6 It is acknowledged that the diversity in the design of power plants imposes challenges in devising one prescriptive test method. This TECHOP thus by design specifically addresses a method of fault ride-through testing for HV power plants typically found on DP MODUs and larger construction vessels.
- 4.1.7 It is important to seek any clarification directly from the appropriate classification society on their specific requirements. Owners are encouraged to do the same with their other relevant stakeholders.
- 4.1.8 For the purpose of this TECHOP and other guidance published by MTS there should be an unambiguous understanding of the use of the word 'simulation'. Simulation in this context is intended to mean the artificial creation of conditions which would develop if a real fault occurred. Examples of this use of the word simulation in this context are:
- Disconnecting a speed pickup on a governor to simulate failure to full fuel.
 - Removing the voltage feedback to an Automatic Voltage Regulator (AVR) to simulate an over excitation fault.
 - Applying a low impedance connection across the outgoing ways of a feeder and closing it to simulate a short circuit fault developing in the power distribution system.
- 4.1.9 Simulation is a term that is used to also indicate numerical analysis or computer modelling. For the purpose of this TECHOP, simulation as used in this context is to be supplemented by additional verification by testing.
- 4.1.10 One of the stated objectives of this TECHOP is to build confidence in the fault ride-through capability of HV power plants operated with their busties closed. It is hoped that the guidance provided in this TECHOP will aid owners to substantiate decisions leading to acceptance of carrying out critical DP operations with power plants configured as a common power system when supported by stakeholder concurrence.
- 4.1.11 It is hoped that this TECHOP will provide the impetus for further innovation and achieve demonstration of fault-ride through of power plants not covered by this TECHOP.

4.2 EXAMPLE OF STATUTORY BODIES INFLUENCING DP REQUIREMENTS (EG USCG)

4.2.1 A DP incident occurred in the Gulf of Mexico in the first quarter of 2013. A MODU operating with busties closed, lost position following a severe voltage dip associated with reconnection of a thruster following maintenance work. In response to this and other incidents, the United States Coast Guard (USCG) Inspections and Compliance Directorate issued Marine Safety Alert 05-13 recommending the following action. See Extract 4-1.

- Perform testing aboard MODUs to ensure functional thruster drives will ride-through a system disturbance. This testing should indicate how the system will react during a significant bus disturbance such as a short circuit on the main switchboard. Where ride-through capability is an essential part of the DP redundancy concept it should be proven by live short circuit and ground fault testing per Section 9.2.5 of the MTS "DP Vessel Design Philosophy Guidelines". This testing should be incorporated into the vessel DP Proving Trial (5-year).

Extract 4-1 USCG Marine Safety Alert

4.2.2 Readers are encouraged to seek confirmation from USCG (if necessary) but it is understood that this recommendation applies to MODUs of DP equipment class 2 & 3 of any year of construction. It applies when the voltage dip ride-through capability is essential to the redundancy concept.

Note: In the intervening period between the issue of marine safety alert 05-13 and publication of this TECHOP; two further DP incidents have occurred in the GOM in which lack of voltage dip ride-through capability was a factor in the undesirable outcome.

5 POWER SYSTEM ATTRIBUTES TO BE VERIFIED

5.1 HYBRID APPROACH TO PROVING FAULT RIDE THROUGH

- 5.1.1 Proving the fault ride-through capability of a common DP power plant requires a combination of computer simulation and physical testing. In general, only one successful fault ride through test is required to validate the modelling work but a range of defined configurations and fault types should be modelled.
- 5.1.2 It is likely to be impractical to carry out the number of tests necessary to prove all possible power system configurations and to do so would most likely violate manufacturer's warranty conditions. Mathematical modelling of power systems using well established products is now a mature practice in power engineering and is considered to produce reliable results when properly executed. However, there will always be uncertainty about how accurately any modelling alone can represent the 'as-built' condition of the power plant given that there may be hidden failures, incorrect settings, deviations from the design, construction errors and so on. Testing and modelling can be combined to provide a much higher level of confidence than either method could provide on its own. Provided the outcome is successful, it is usually only necessary to perform one fault ride-through test, even on power systems with a three or four way split. Although validation of the model is performed in one configuration, the scaling required to predict plant response in other configurations is typically of the order of 1:3 so the results do not have to be scaled by orders of magnitude which might create a greater degree of uncertainty.
- 5.1.3 Further cross checking can be accomplished by using the model to predict the outcome of other studies using different methods such as the short circuit calculations for example. The modelling and results are then submitted to class for further scrutiny.
- 5.1.4 The results of the short circuit test can be used to fine tune the initial model by providing more accurate information of the generator decrement curve compared to that provided by the generator manufacturer.

5.2 ATTRIBUTES TO BE PROVEN

- 5.2.1 Power system attributes which should be proven by a combination of computer simulation and testing to demonstrate fault ride-through capability are:

1. The voltage dip ride-through capability of the entire plant is to be proven. This is most effectively done by testing. This type of test will help to reveal hidden failures, incorrect settings and design deficiencies associated with voltage dip ride through. The voltage dip created during a properly executed fault ride-through test is representative of the voltage dip with the greatest magnitude and duration that is expected.
2. The coordination of the primary over current protection (busties). The primary protection is that which opens the bustie circuit breakers to isolate a fault to one redundant equipment group (e.g. one switchboard). This protection is proven by a combination of modelling and testing. A fault ride-through test is performed on the entire power system by introducing a test fault on one main switchboard.

In the case of a vessel with a two-way split and thus two main switchboards the complete protection system is tested (all busties trip).

In the case of a three-way or four-way split not all busties may trip depending on the design. In the case of such designs, it is generally acceptable to perform a single fault ride-through test on the whole plant by introducing a test fault on one switchboard (only busties that isolate that switchboard will trip). Confidence in the other busties is provided by:

- a. The results of the modelling work are able to accurately predict the power plant response.
 - b. The commissioning tests such as secondary injection tests were successfully carried out.
 - c. Inspection of protection and control systems settings confirm they are identical.
 - d. The test is carried out with all switchboards energised.
 - e. Testing those busties if carrying out a periodic repeat of the test.
3. The transient stability of the surviving generators should be proven. This is satisfied by proving that surviving generators remain in synchronism following clearance of a short circuit fault. Once again, the single fault ride-through test result can be used to validate the model used to test all other combinations. This can be done in two ways:
- a. By carrying out the fault ride-through test with three generators online (two on one switchboard and one on another) and observing that the surviving two generators on the same switchboard remain in synchronism after a fault is cleared on the other switchboard. A higher test current will be developed.
 - b. By carrying out the test with two generators online (one on each side of the tie line and recording the terminal voltage waveform before and after the bustie opens and observing that the voltage produced by the two machines remain in synchronism for a defined time. They may subsequently drift apart. This method produces the lowest test current.
4. It is necessary to prove the generators can deliver sufficient fault current to operate the over current protection scheme selectively. The fault ride-through test can prove this for those generators used during the test. For other generators, a controlled excitation test can be used to demonstrate that the other generators are capable of delivering the required current.
5. It is necessary to prove that the reaction of the excitation system during the recovery phase of the fault does not trip the plant on overvoltage. The fault ride-through test can provide some evidence that this is the case backed up by the model prediction in other combinations. The facility to evaluate the potential for damaging over voltages is another benefit of modelling.
6. The drive dc link does not trip on under or over voltage. The fault ride-through test can help to confirm that the 'voltage doubling' effect does not raise the dc link voltage to the level at which the drive's protection systems will shut it down. Where a significant overvoltage does occur, the fault ride-through test can also prove the correct operation of dynamic braking resistors in limiting the voltage rise on the drive dc link. The model prediction can then be used to confirm correct operation in other configurations. Where ride through depends on kinetic energy recovery, the proper operation of this feature can be confirmed and the extent to which this is effective at low propeller speeds may be confirmed by modelling. The proper response of the drive power limit can be observed and that thrust is available upon recovery of the power system. Kinetic energy recovery or kinetic buffering are methods of preventing the dc link voltage failing to unacceptably low levels during the voltage dip. During the recovery process the motor is made to generate power from the energy available from the rotating propeller and return it to the capacitor bank that forms the dc link between rectifier and inverter in a voltage source variable speed drive. Failing to maintain adequate dc link voltage forces the drive controller to open the feeder circuit breaker to prevent the charging current causing damage. The drive can be reenergised automatically but the pre-charging process requires time to restore link voltage at a controlled rate before the thruster feeder circuit breaker can be re closed to make the thruster available to DP.

7. The coordination of the earth fault protection scheme can be verified under realistic conditions.
8. It is necessary to prove that the power system can survive the worst case crash synchronisation that could occur as the result of a single failure or act of maloperation. The failure effects can be particularly severe and methods to reduce the risk of such failures occurring are discussed in rules and guidance. At present, this attribute is proven predominantly by modelling work. It may be possible to limit the study to generator crash synchronisation if the FMEA can demonstrate that a single failure or inadvertent act cannot lead to two power systems being crash synchronised.
9. It is necessary to prove that the power plant can survive the inadvertent connection of a stopped generator.
10. It is necessary to prove the power plant can withstand a severe engine or alternator failure which decelerates the rotor so rapidly that synchronism may be lost.
11. It is necessary to confirm the accuracy of the generator decrement curve used in the model. A fault ride-through test provides this information.
12. A range of fault types need to be considered. The fault ride-through test uses a bolted three phase short circuit which is also securely referenced to earth (ship's hull). Two phase faults involving earth, or not, also need to be investigated as do arcing faults. The nature of arcing faults is chaotic but the consequences are satisfactorily addressed in protection system designs and models.
13. All attributes - The validated model should then be used to confirm an acceptable response in all other defined power plant configurations and fault types with different numbers of thrusters, generators and transformers. These configurations may include closed ring, linear bus and asymmetric combinations.
14. Other faults that need to be addressed which are not covered within this TECHOP on fault ride-through include:
 - a. Excitation control failure.
 - b. Fuel control failures.
 - c. Load acceptance and rejection issues.
 - d. Pre-mag & pre-charge failures.
 - e. Unbalanced loads.
 - f. Failure leading to increased harmonic distortion.
 - g. Power management system faults.

5.2.2 Protection schemes or power system designs which may present insurmountable or unreasonable challenges in respect of proving fault ride through should not be chosen for DP systems.

5.2.3 **Fault Ride Through Definition:** In general terms, the DP system can be considered to have ridden through the fault if thrust levels are restored to pre fault conditions on clearance of the fault and all equipment other than that which must be isolated to clear the fault remains operational without restart or operator intervention. There is no loss or unacceptable excursion in position or heading.

6 EXPERTISE REQUIRED FOR CARRYING OUT FAULT RIDE-THROUGH TESTING

6.1 INITIAL WORK

6.1.1 The initial work on this subject, in the maritime sector, has been carried out by the major equipment manufacturers in close cooperation with vessel owners and classification societies. In most cases, the testing was being carried out on the manufacturer's own equipment on new buildings or vessels just entering service but some older generation vessels have been successfully tested too. At the time the draft revision of this TECHOP was published, around ten fault ride-through tests had been successfully carried out on DP vessels of various types. By the time the final revision (Ver5) was published, shipyards in China, Korea and Singapore had all successfully completed fault ride through tests.

6.2 EXPERTISE

6.2.1 The type of expertise required to carry out this type of testing and modelling lies with those who design, build, install and commission large marine High Voltage (HV) power plant such as Siemens, ABB, GE etc. Organisations of this type also have the test equipment, software and facilities to carry out the modelling and simulation work such as Real Time Digital Simulation or Hardware-in-the Loop testing.

6.2.2 Note: In the context of this document the term High Voltage (HV) is synonymous with Medium Voltage (MV). Rules and guidelines for marine systems do not normally define an MV level only HV and LV. Typically, any voltage equal to or greater than 1kV is classified as HV for marine use. On shore side installations 6.6kV & 11kV would be classed as MV and it is familiarity with this type and rating of equipment that is required in most cases.

6.2.3 Even before fault ride-through testing was practiced by the DP community, the major power companies have used this kind of expertise for other purposes, including military contracts. Fault ride-through testing has also been carried out by some power system vendors on fixed offshore platforms.

6.2.4 Expertise also exists in specialist protection companies such as those responsible for developing advanced generator protection systems. Some classification societies have experience of carrying out fault ride-through testing on vessels before and after its introduction to DP.

6.2.5 Although the test procedure and setup is relatively straight forward, this type of testing requires the participation of a strong electrical engineering team with a good combination of theoretical knowledge and practical experience of high voltage power systems. When properly planned and executed, the risks are no greater than those associated with any other tests where there are significant amounts of potential energy, such as full load testing for example. The Oil & Gas industry uses well established hazard effects management processes to manage risks of this nature on a daily basis and knowledge and proficiency in risk management techniques is an essential competency for any team carrying out this type of work.

6.2.6 The major power companies who contributed to the production of this TECHOP did not foresee, in principle, any major problems in carrying out the necessary testing and modelling work on power systems designed and built by others but there may be additional survey requirement and it may be necessary for the original equipment manufacturers to make available black box models of certain elements of the power system. The model could be specified as a deliverable from the power system supplier.

6.2.7 No testing or other work should be carried out until it has been demonstrated to be safe.

6.3 QUALIFICATION AND APPROVAL

6.3.1 In any process which contributes to the award of a class notation there may be elements of approval and pre-qualification associated with the means used to satisfy class requirements and these should be discussed with the classifications societies if there is any doubt: Typical example of issue where it would be prudent to seek confirmation are:

- Test programs as part of dockside or as part of sea trials should be approved by class. Are class satisfied that carrying out certain tests alongside is acceptable to them?
- Methods used for simulation and modelling may require prior approval. For example, short circuit withstand calculations are normally based on methods described in IEC 61363 or another recognised standard. Any modelling or simulation packages used as part of the process of proving fault ride-through capability may also need pre-approval.
- The accuracy of the model may be influenced by several factors including the information provided on equipment electrical characteristics. This is one of the primary reasons for using the test data to cross check the model and not relying solely on computer simulation.

6.3.2 When testing is carried out as part of the build phase, the responsibility for overall safety typically lies with the shipyard. Whoever holds overall responsibility, it is essential that all participants comply with all relevant rules and requirements for workplace safety. However, the risks associated with carrying out fault ride through testing do not appear to be substantially different to those associated with constructing and commissioning a HV power plant.

6.3.3 It is expected that new service providers will emerge and it may be prudent for ship owners or those responsible for commissioning the services of such providers to engage in a formal qualification process prior to selection. A review of capabilities such as mathematical modelling, safety management systems and other relevant procedures may form part of that process. An established track record of incident free projects may be one of the more reliable indicators.

6.3.4 Once the test has been carried out, any changes to protection or control systems settings which could influence fault ride through capability should be avoided. Where this is not possible the impacts should be assessed using the mathematical model and referred to the relevant classification society.

6.4 ROLES AND RESPONSIBILITIES

6.4.1 Roles and responsibilities for testing may vary from case to case depending on the phase of the vessel's life cycle. It is important that the roles and responsibilities are well defined long before the execution stage and classification societies may wish to consider defining these roles within the rules for the appropriate class notations. As an example, the roles and responsibilities for a test being carried out prior to vessel delivery could be as follows:

Table 6-1 Roles and Responsibilities

Stakeholder	Responsible for:
Shipyard	<p>Contractually obliged to deliver a vessel that satisfies classification society rules in respect of the required DP notation and overall responsibility for the safe conduct of the testing. Responsible for:</p> <ul style="list-style-type: none"> • The safety of the vessel alongside and on sea trials • Facilitating the work of the power system supplier in carrying out the testing • Facilitating the risk assessment and implementing its findings • Liaison between the major power system provider and vendors supplying other parts of the power system subject to testing.
Power System Vendor	<ul style="list-style-type: none"> • Commissioning the HV power plant after mechanical completion • Creating confidence in the fault ride-through test result by preparatory testing. • Carrying out the fault ride-through and earth fault test • Recording the test data • Carrying out the modelling work • Presenting the test results and modelling work to the classification society through the shipyard
DP System FMEA Provider	<ul style="list-style-type: none"> • Observing the tests being carried out and noting the high level test result in the DP FMEA proving trials. • Responsible for integrating the high level conclusions of the test and modelling work carried out by the power systems vendor into the DP FMEA to address the various failure modes that required verification on the basis of such supporting studies. For example, effects of short circuits at various points and associated voltage dip ride-through.
Classification Society	<ul style="list-style-type: none"> • Setting the rules which must be complied with, including setting out requirements for acceptable modelling methods and packages. • Approving the technical aspects of the test program and overall sea trials program. (Note: safety aspects are the responsibility of those carrying out the tests) • Approving the power plant configuration to which the test and modelling results apply and confirming the notation that can be expected upon successful completion. • Observing that the testing is carried out as per the approved program. • Reviewing the reports which demonstrate how the test results validate the mathematical modelling. • Review the reports generated by the modelling and simulation work to confirm there are no unacceptable failure effects. • Review the DP system FMEA to confirm the failure modes raised in it are addressed by the combined results of the modelling and testing with reference to the appropriate test documents and supporting studies.
Vessel Owner	<p>Observe testing and review modelling work for evidence of compliance with any issues of specification agreed with shipyard.</p>

6.5 ACTION IN THE EVENT OF AN UNSUCCESSFUL TEST

- 6.5.1 Because there may be practical and contractual limits to the number of fault ride-through tests that can be carried out it is essential that all reasonable steps are taken to ensure a successful outcome before carrying out the test. Note: for the purposes of this TECHOP a successful test result is one that provides all the information required to confirm the plant has adequate fault ride-through capability contributing to award of the appropriate DP notation. As modelling work should be carried out prior to the fault ride-through test it is assumed no one would proceed to confirm that a power plant has no ride-through capability.
- 6.5.2 Despite all necessary preparations being taken, it is not unreasonable to anticipate that there may be an unsuccessful result on the first test attempt, in which case there are benefits to having all data loggers and history stations operating to give the greatest chance of identifying the reason and rectifying it with certainty so that the next test will be successful.
- 6.5.3 As the switchgear is only tested at a fraction of its design capability the effect on generators is the limiting factor. Typically, manufacturers rate generators for a defined number of short circuit events before the warranty is considered to be void. A pre-requisite to testing is to ensure that OEM has been consulted and impacts of such testing are understood, addressed and managed. These impacts are to be made visible to all stakeholders involved with the testing. Example, an HV power plant configured with six generators each rated for three short circuit events. With planning and proper execution such a vessel could test over a period of forty years with a test interval of five years if each test was successful.
- 6.5.4 Earth fault tests may also be repeated periodically as the tests use all the same equipment. Earth fault tests do not stress the generators in the same way and therefore do not count towards the limits described above.
- 6.5.5 The situation which should be avoided is to troubleshoot any unsuccessful test result by carrying out more and more fault ride-through tests when there is a poor understanding of the reasons why the plant will not ride-through without effects exceeding the worst case failure design intent.
- 6.5.6 In the event that any component or element of the systems does not perform as expected, the reasons for this should be fully understood before proceeding to carry out further testing. In particular, if there is any indication of a design flaw.
- 6.5.7 A different combination of generators can be used to prevent manufacturer's specifications or limitations from being exceeded.
- 6.5.8 Any changes in protection or thruster drive settings may require the modelled results to be updated.
- 6.5.9 Based on past experience, the possibility of having to carry out a large number of tests to achieve a satisfactory result is low but the possibility of having to carry out more than one test is reasonably foreseeable. As such, it may be prudent to specify in contracts and agree what is to be done in the event that such an unfortunate situation occurs.

7 INDUSTRY READINESS FOR TESTING

7.1 VESSEL CATEGORIES

7.1.1 Three categories of vessel can be identified:

- Newbuildings with DP notations which require testing.
- DP vessels in service with HV power plant.
- DP vessels (newbuildings or in service) with LV power plant.

7.1.2 Newbuild DP vessels with notations requiring testing. By default, these vessels are built to be tested and it is expected that this objective is met from design inception. Such designs are intended to have equal integrity with power plants based on open busties as described in IMO MSC 645 Section 3.2.4. See Extract 7-1.

Note: The determination of CAM and TAM operations and acceptable configuration should be based on suitable and sufficient hazard effects management processes.

3.2.4 For equipment class 3, the power system should be divisible into two or more systems such that in the event of failure of one system, at least one other system will remain in operation. The divided power system should be located in different spaces separated by A.60 class division. Where the power systems are

IMCA - 113 IMO

Page 9

Guidelines for Vessels with Dynamic Positioning Systems

IMO MSC Circular 645

located below the operational waterline, the separation should also be watertight. Bus-tie breakers should be open during equipment class 3 operations unless equivalent integrity of power operation can be accepted according to 3.1.3.

Extract 7-1 IMO Requirement for Equal Integrity

7.1.3 DP vessels in service with HV power plant intending to carry out critical operations with busties closed. Demonstrating fault ride through capability in the manner described in this guidance may not be adequate to satisfy all stakeholder requirements to demonstrate equal integrity as an open bus configuration. Additional verification, validation and potentially, equipment / features may be required. Clarifications on such requirements should be sought from all appropriate stakeholders.

7.1.4 LV power plant: There are practical difficulties in testing low voltage power systems because, unlike their HV counterparts, the fault currents are very high and the switchgear may be rated for far fewer faults before overhaul or replacement is required. Such vessels tend to have fewer generators (typically four) and so any test with two generators could be at a higher fraction of the design withstand level. Although short circuit testing for other purposes has been carried out on LV power systems, there is no well-established, DP specific, method for proving the fault ride-through capability of these vessels. Although proposals are being developed by power plant designers, there is no schedule for publication at this time. It is expected that the same level of confidence and verification will need to be established even though the means of verification may be different for those used for HV power systems.

7.1.5 Build to test philosophy: Throughout this TECHOP references are made to the 'build to test' philosophy. This philosophy recognises the need for periodic verification of attributes upon which the station keeping integrity of a DP system depends and includes design features and attributes in the DP system which enables such testing to be carried out safely and effectively. Practical implementations of the build to test philosophy would include:

- Ensuring the DP system has all the protective functions and other attributes it needs and provides a convenient means to exercise and prove them periodically.
- Pre-installing test points and recording facilities.
- Ensuring the power plant design has adequate margins to cope comfortably with any stress created by testing.

7.1.6 The objective of the build to test philosophy is to avoid creating DP system designs which cannot be properly tested because there is uncertainty about the risk of equipment damage or personnel safety.

7.2 PURPOSE OF TESTING

7.2.1 Fault ride through testing is an important part of proving the robustness of a DP vessel intending to operate with its busties closed regardless of the class notation it has or aspires to achieve. The USCG recommends fault ride through testing for any class of MODU reflecting the reality that vessels, regardless of the class notation, are exposed to the same risks and consequences.

7.2.2 The use of the term 'Short Circuit Testing' to describe the process of proving the fault-ride-through capability of the power plant may have caused some confusion and unnecessary concern. In other fields of power system engineering the term 'Short Circuit Testing' is used to mean a full current test to prove the strength of the equipment and its ability to withstand the forces developed by the fault currents. This type of testing is carried out (2) on some types of power distribution equipment entering service. In particular, on large transformers where the commercial and social impact of a long outage could be significant.

7.2.3 This is not the purpose of testing in the DP application and for this reason the practice would be better referred to and is referred to in this TECHOP as 'proving fault-ride through capability'. The testing carried out on DP vessels is done to prove elements of the protection system and the ride through capability of the power consumers such as thrusters and auxiliary systems.

7.2.4 Fault ride-through testing carried out on DP vessels is performed at a fraction of the withstand rating of the switchboards. Only one circuit breaker sees the total current and this circuit breaker can be replaced if desired without invalidating the test result.

7.2.5 Fault ride-through testing on its own is not sufficient to prove that a DP power plant operating with closed busties has equal integrity to that provided by operating a power plant as multiple independent power systems. It is for this reason that it is most suitable and most appropriate to perform this type of testing when the vessel will be built to comply with all the other requirements of the relevant DP notations which require fault ride through testing.

7.2.6 The commissioning tests carried out during the build phase such as hi-pot testing, Ductor testing, secondary injection and so on are to be supplemented by additional verification by testing to provide a sufficient level of confidence in the fault ride-through capability. There are two main reasons for this:

- The lack of ride through capability is not usually associated with the attributes proven by these commissioning tests.
- The industry continues to experience DP incidents where lack of ride-through capability caused the severity of the failure effect to exceed the worst case failure design intent, demonstrating that current practices of testing need to be supplemented by other methods.

7.2.7 It is not the primary purpose of fault ride through testing to find hidden faults although experience confirms that such faults have been revealed by testing.

7.3 CONCERNS TO BE ADDRESSED WHILE EXECUTING FAULT RIDE-THROUGH TESTING

7.3.1 The following concerns should be addressed:

- The safety of crew members and other persons onboard.
- The safety of personnel carrying out the testing.
- Commercial considerations related to equipment damage or non-productive time.

7.3.2 The safety of crew members: The safety of crew members depends on the ability of the power plant to contain the energy released by fault conditions. A power system fault causing a severe voltage dip is a reasonably foreseeable event. Each year several vessels in the DP fleet experience such faults. Some vessels will not experience such a fault during their operational lifespan but others may experience two or more such faults.

7.3.3 Industry bodies such as IEC and NEMA develop standards intended to ensure power systems are designed to withstand the electrical and mechanical stresses associated with such faults. In the case of DP class 2 and DP class 3 vessels operating with closed busties at least one redundant DP equipment group must remain in operation after being exposed to such forces.

7.3.4 Thus, if there are any concerns about the strength of a particular power plant or its reliability after a fault it is difficult to justify operating such a power plant as a common power system for the following reasons:

- The whole plant will experience the mechanical and electrical stresses. Therefore, the redundancy concept may be defeated if there is any possibility that healthy machinery could be damaged.
- The fault current and therefore the forces will always be larger when operating with the busties closed.
- Following any blackout or machinery stop caused by the fault, automatic systems will be restarting machinery and the crew will be investigating the fault, thus any machinery not isolated by protection but exposed to fault conditions must remain safe to operate.

- 7.3.5 Thus, any risk assessment process that concludes there are reasons not to subject a suitable DP power plant to limited fault ride-through testing on personnel safety grounds should objectively validate and document the basis of decision concluding that it is safe to operate with busties closed given the potential for experiencing the conditions described in the bullet points above.
- 7.3.6 The safety of personnel carrying out the testing: HV switchgear has a very good reputation for safety when built to the appropriate standards referenced in classification society rules. The use of gas filled (SF₆) switchgear, fully insulated bus bars and vacuum interrupter technology means that faults can be isolated with much greater certainly and security than older technologies based on air circuit breakers and magnetic induction relays. Many HV switchboards are arc proof and have optical or pressure based arc detection and protection. Most injuries or fatalities that involve withdrawable HV switchgear are related to a well-documented group of incidents that occur when manoeuvring this type of switchgear in and out of switchboards (3) when the bus bars are live. These incidents are often related to faults in the primary contacts or stabs, foreign objects left in the circuit breaker and so on.
- 7.3.7 In the case of DP vessel power plant, the risk to personnel can be addressed by removing them from the danger areas during testing.
- 7.3.8 Further safety measures include:
- De-energising the bus bars while the circuit breaker is inserted and removed.
 - Remote racking gear can be used.
 - The circuit breakers can be opened and closed remotely.
 - Access to risk areas can be controlled by locking.
 - All the required test equipment connection points can be engineered in during the build phase.
 - Allow adequate time for preparation and execution in a controlled environment.
- 7.3.9 In general terms, there are no activities in the preparation for or execution of a fault ride-through test that are significantly different to general commissioning activities. As can be seen from the description of some of the test methods employed there is a very minimum of intrusion. Some designs of modern gas filled marine switchboards have non-removable switchgear thus eliminating one failure cause altogether.
- 7.3.10 Concerns based on safety grounds associated with equipment failure are difficult to reconcile. The equipment under test is type approved and designed to withstand significantly higher forces than those produced during the test. These tests can be conducted under controlled conditions to ensure personnel safety. On the other hand, a real short circuit fault may occur at any time and thus personnel are exposed to its effects without warning. If the ability of the equipment to contain a significant release of energy is a genuine concern, then it could be argued that it is better to discover this deficiency under controlled conditions than to experience the effects for the first time with no preparation when connected to a live well or while conducting other critical operations.
- 7.3.11 Vessel owners may wish to review their safety process for working on electrical power systems. Safety developments such as remote racking gear, and improved Personal Protective Equipment (PPE) for operators are available and in use on shore based utilities but not yet universally adopted by the marine sector.

- 7.3.12 The oil and gas industry successfully manages risks associated with many high energy processes using well established HEMP and fault ride-through testing is no different in that respect. Complacency is one of the greatest risks to safety and a healthy respect for the dangers of HV power plant should be encouraged. Suitable and sufficient risk assessments performed by competent bodies should form an integral part of preparations.
- 7.3.13 The possibility that the vessel fails the test resulting in non-productive time and loss of revenue: This risk can be minimised by carrying out the testing at an appropriate time such as pre delivery, periodic surveys and after dry dockings. The least effective time to perform the test is following an incident which has just proved the power plant has no ride-through capability.
- 7.3.14 It is important to recognise that equipment can fail. Like many other equipment types, electrical equipment is at its least reliable early in its life and as it reaches the end of its service life. Electrical equipment with an inherent weakness may fail when stressed. Very occasionally such a weakness may not be revealed by the commissioning and factory tests to which it is subjected. As fault ride-through testing is also a comparatively low stress test it cannot be relied upon to reveal such weaknesses but can help to prove the power plant can survive the eventual failure effects and maintain position.
- 7.3.15 Concerns regarding liability for equipment damage during testing are to be addressed. Precedent exists in current shipbuilding practices to effectively address such concerns and it is expected that this issue and resolution will be made transparent and visible to all stakeholders. It is expected that the methodology described in this TECHOP will aid due diligence efforts of all parties to manage the risk to ALARP.
- 7.3.16 Concerns relating to reduction in equipment lifetime imposed by testing. Concerns have been raised in relation to the need to service or replace switchgear more frequently or carry out replacement of bus bars and their restraints etc. Tests carried out in accordance with the methods described in this TECHOP are not expected to adversely affect system reliability or require more frequent maintenance because the currents and forces are within rating and a fraction of rating for all but the generators used for the test. Tests using the methods described in this TECHOP have been performed since around 2011. This TECHOP in all cases strongly recommends vessel owners to seek the advice of competent bodies to determine suitability for testing. Evaluating the potential for reduced reliability should be part of the process of determination of suitability. Industry experience has shown that DP vessels do experience short circuit faults at levels well above those experienced in fault ride through testing. It is expected that vessel owners have developed implementable contingency plans to deal with such events.

8 PRACTICAL CONSIDERATIONS FOR CARRYING OUT TESTING

8.1 INTRODUCTION

8.1.1 The fundamental difference between a real short circuit fault and a fault ride-through test is that in a properly planned and executed fault ride-through test there is no significant release of energy. In a real fault there is likely to be a rapid rise in pressures and temperatures associated with arc formation and explosive venting of the hot gasses. Even if the faulty equipment performs as intended and limits the severity of the failure effects there may be charring and deformation of the enclosure. Short circuit testing carried out on switchboards and MCCs to prove their ability to contain such effects does involve creating such conditions. The fault ride-through testing on DP vessels described in this TECHOP does not.

8.1.2 It should also be noted that switchgear and associated bus-work is typically designed to handle the combined fault current of all connected generators and loads. Because switchboards are designed in a range of standard fault ratings this usually means the switchboard is rated for a significant margin over and above the actual fault current level.

8.2 ESTIMATING SHORT CIRCUIT CURRENTS

8.2.1 Methods for calculating short circuit currents are well established and international standards exist for this purpose. The International Electro-technical Commission (IEC) and other bodies publish standards which provide methods for calculating the short circuit current at selected points in a power distribution system and at selected times during the development of the fault current. Examples of such standards include:

- IEC 60909-0, 'Short circuit currents in three-phase systems – Part 0, Calculation of currents.'
- IEC 61363-1, 'Electrical installations of ships and mobile and fixed offshore units – Part 1 Procedures for calculating short-circuit currents in three-phase a.c.'

8.2.2 From IEC 61363-1 '*A marine and offshore structure electrical system should be designed to ensure that all possible precautions have been taken to prevent short-circuit currents occurring. The principal objective of calculating the short-circuit current is to ensure that the system and its components are capable of withstanding the effects of the short-circuit conditions, and thereby limit any resulting damage to a minimum.*'

8.2.3 There is nothing within these standards that requires the non-faulted parts of the power system to remain in operation without malfunction once the fault has been cleared. Therefore, compliance with the parts of the standards referenced above is only an indicator of the system's ability to limit the severity of failure effects in terms of their ability to cause damage and not to prevent a loss of position.

8.2.4 The procedures provided in international standards generally include some degree of simplification or other assumptions intended to reduce the effort required to calculate the values of short circuit current in various scenarios. These simplifications result in some inaccuracy but the errors so created are not significant for the purposes for which the calculations are required. Advances in mathematical modelling of power systems and increases in computing power mean that these simplifications are no longer so necessary but studies produced by some computer simulations continue to make reference to the relevant standards. Such simplifications should not be made if they reduce the accuracy of the model to the point where it compromises its accuracy for the purpose of fault ride through verification.

- 8.2.5 In a diesel electric power plant, the largest contributors to short-circuit current are the generators, but transformers, motors and certain types of variable speed drive can also contribute significant current to a fault. The formulae for calculating the current contribution of a synchronous generator $i(t)$ to a fault near the generator itself is given in Equation 8-1 to Equation 8-5. (Variables are defined in the test that follows)

$$a(t) := E \sqrt{2} \left(\left(\frac{1}{x''_d} - \frac{1}{x'_d} \right) e^{\left(\frac{-t}{T''_d} \right)} \right) \cdot \cos(\omega \cdot t)$$

Equation 8-1

$$b(t) := E \sqrt{2} \cdot \left(\left(\frac{1}{x'_d} - \frac{1}{x_d} \right) e^{\left(\frac{-t}{T'_d} \right)} \right) \cdot \cos(\omega \cdot t)$$

Equation 8-2

$$c(t) := E \sqrt{2} \cdot \left(\frac{1}{x_d} \right) \cdot \cos(\omega \cdot t)$$

Equation 8-3

$$d(t) := - \left(\frac{E \sqrt{2}}{x''_d} e^{\left(\frac{-t}{T''_d} \right)} \right)$$

Equation 8-4

$$i(t) := a(t) + b(t) + c(t) + d(t)$$

Equation 8-5

- 8.2.6 In common with some other standards, the contribution to the overall short circuit current is approximated to be the sum of three ac currents and a dc component provided by voltages behind impedances which decay at different rates. These impedances are associated with the direct axis of the machine. The impedances for the quadrature axis are neglected to simplify the calculation but this is said to reduce accuracy by no more than 10%. These impedances and their associated time constants are given the symbols below and are measured in Ohms (Ω) and seconds (s) respectively:

Sub transient reactance	x''_d	T''_d
Transient reactance	x'_d	T'_d
Synchronous reactance	x_d	

- 8.2.7 The three ac contributions are calculated using Equation 8-1 to Equation 8-3 above and the dc contribution by using Equation 8-4.

- 8.2.8 The waveforms given in Figure 8-1 to Figure 8-4 were produced using typical data for an 8MVA, 11kV, 60Hz generator (see below), where E = phase voltage (V), f = frequency (Hz), t = time (s) and T_a is the time constant in seconds for the aperiodic or dc component.

$$\begin{aligned}
 E &:= 6350 & f &:= 60 & x''_d &:= 1.93 & x'_d &:= 3.599 & x_d &:= 8.34 \\
 T'_{do} &:= 1.1393 & T''_{do} &:= 0.0158 & \omega &:= 2 \pi \cdot f & T_a &:= 0.05 \\
 T'_d &:= \frac{x'_d}{x_d} \cdot T'_{do} & T''_d &:= \frac{x''_d}{x'_d} \cdot T''_{do} \\
 t &:= 0, 0.001 \dots 0.5
 \end{aligned}$$

Equation 8-6

- 8.2.9 Combining these results in Equation 8-5 creates the familiar short circuit current waveform shown in Figure 8-5. An initial current of around 7kA peak decays within 12 cycles to 1350A rms.

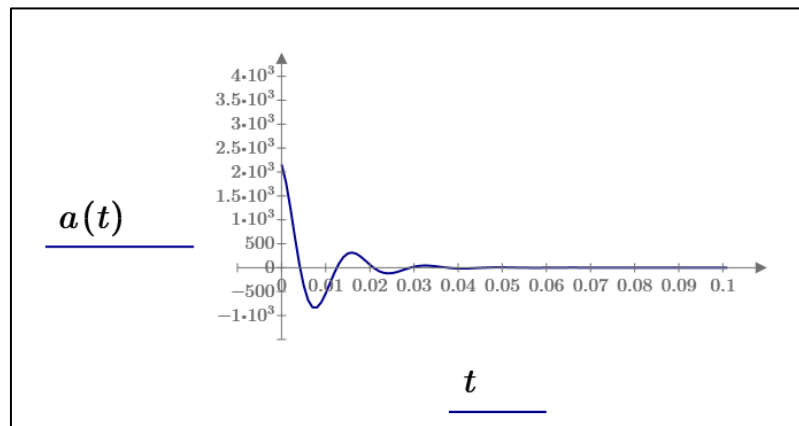

Figure 8-1 Sub Transient

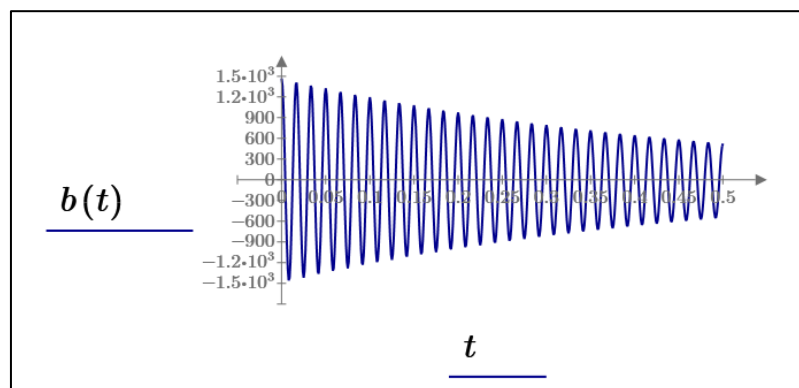

Figure 8-2 Transient

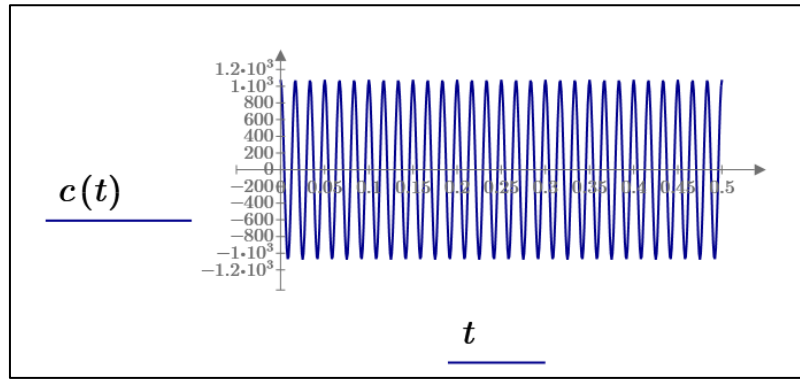

Figure 8-3 Synchronous

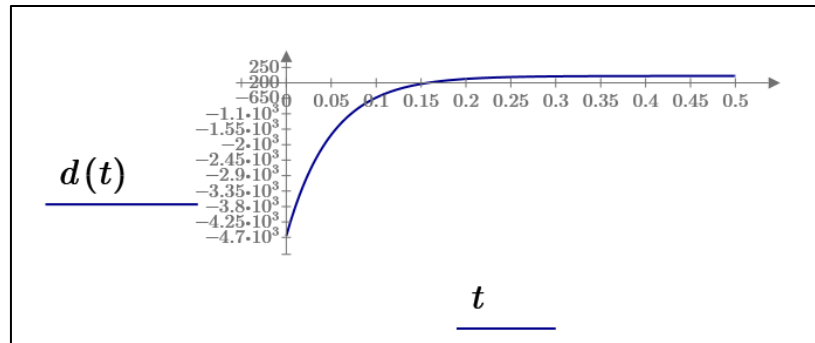

Figure 8-4 Aperiodic or dc Component

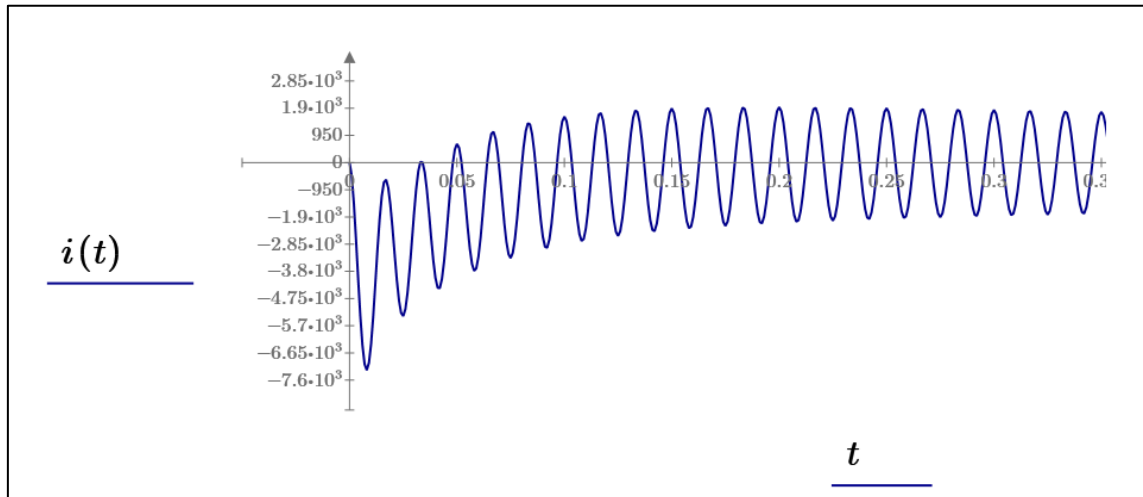

Figure 8-5 Short Circuit Current Waveform

- 8.2.10 In practice, it is not necessary to compute the short circuit waveform at every point and short circuit studies typically provide peak and rms values at defined numbers of cycles which are important for the time at which the switchgear operates. As the current changes with time after the fault it is important to know the magnitude of current the switchgear will interrupt.
- 8.2.11 The example given above was for a synchronous generator. The standards provide equations for other type of electrical equipment and methods for combining their contribution.

- 8.2.12 Although calculations of this nature are acceptable for determining the withstand, making and breaking capacities required of the switchgear it is expected that much more sophisticated dynamic computer simulations will be required to satisfy the classifications societies that the power system is fault tolerant over its full range of operating configurations.

8.3 PREPARING FOR THE TEST

- 8.3.1 In preparing to conduct a fault ride-through test it is essential to do everything possible to ensure a successful test result first time. Although none of the equipment is stressed beyond its rating, there are limits to the number of times generators and circuit breakers can be stressed and thus limits to the number of times they can be tested without violating warranty agreements. This number is defined by the manufacturer and may be low. It is however possible to design generators for any number of short circuit tests. Such machines may be offered by vendors or referenced in vessel specifications. Manufacturers specifications should not be exceeded.

- 8.3.2 To ensure a successful outcome first time, a well-planned test program should include a number of preparatory studies and tests as part of the commissioning process. These preparatory tests are all low stress tests designed to confirm the correct operation of the power plant and protection so that there is a high level of confidence that a successful fault ride-through test will be achieved and a high level of confidence that there will be no unsatisfactory effects.

- 8.3.3 In principle, this type of testing could be carried out as part of full scale integration testing if all the propulsion equipment including generators, HV/LV switchboards, transformers, cables, pumps, drives, motors, thrusters, UPSs and auxiliary systems could be assembled in one place but there would still be a risk of introducing faults during the subsequent installation and re-commission on the vessel which could limit stakeholder confidence in the test results. Assembling all the propulsion equipment at one time in one location presents significant logistics and administrative challenges. Experience gained from testing suggests there may be no significant advantage in doing this.

- 8.3.4 Fault ride through testing should be carried out in addition to all the tests and commissioning activities normally associated with an HV power plant. It is not intended to substitute for established methods in any way.

8.4 PREPARATORY ANALYSIS

- 8.4.1 All of the power system vendors contacted as part of this study carry out mathematical modelling of the system and some plan to use, or are supportive of the concept of using, techniques such as Real Time Digital Simulation (RTDS) or Hardware-in-the-Loop (HIL) testing to extend the range of faults that can be investigated and to reduce the need for excessive testing. This TECHOP fully supports and endorses the use of RTDS or equivalents as an essential part of the process of proving fault ride through testing.

- 8.4.2 Computer modelling of the type discussed above is a prerequisite of any verification by testing of fault ride-through capability. This TECHOP does not address whether computer modelling on its own would satisfy all stakeholder expectations.

Note: Users of RTDS have commented that the models currently used are appropriate as a complementary technique to other verification methods rather than a standalone technique.

- 8.4.3 Preparatory analysis should confirm the correct response of all protective functions to a full range of fault types including asymmetrical faults and arcing faults so that there is a high degree of confidence in a successful outcome at the final fault ride through test.

- 8.4.4 There may be a need for some re-analysis if the actual generator decrement curve recorded during the test differs from the curve used before the test or there is a need to change protection settings.
- 8.4.5 As discussed within this TECHOP, acceptance criteria should be clearly and unambiguously agreed to by all stakeholders.
- 8.4.6 Special attention may be required on power systems with harmonic filters. Manufacturer's advice should be sought.

8.5 PREPARATORY TESTING

8.5.1 In addition to all the usual processes associated with commissioning an HV power plant the following activities could form part of the preparatory work leading up to the fault ride-through test.

1. Testing arc detection where fitted.
2. Current and voltage injection testing for:
 - a. Protection relays.
 - b. Automatic voltage regulators.
 - c. Governor.
 - d. Synchronisers.
 - e. Sync check devices.
 - f. Switchboard interlocking.
3. Controlled generator field increase to short circuit at a predetermined point in system (feeder, bus-bar etc.). This test can prove correct operation of:
 - a. Automatic voltage regulators.
 - b. Protection relays.
 - c. Governor.
4. Voltage dip ride-through. This can be tested by cycling a circuit breaker open and closed under remote control within 1s (typically). This contributes to knowledge of the voltage dip ride-through capability of:
 - a. Low voltage switchboards.
 - b. Variable speed drives including kinetic recovery.

Note: Practical experience of using this method indicates that there can be problems with inrush current tripping circuit breakers in a manner that is not representative of the way the system would recover from a real short circuit. The suitability of this test method needs to be validated on a case by case basis.

1. Real Time Digital Simulation (RTDS) test of protection relays pre Factory Acceptance Test (FAT) (see Section 9.1.4 for further details of RTDS).
 2. RTDS test of advanced protection for generators (protection for parallel operation) pre FAT.
 3. RTDS test of governor and AVR controls.
 4. RTDS test for thruster and drilling drive controls and protection.
- 8.5.2 All of these tests have their own limitations but together they provide a great deal of information regarding the readiness of the plant to undergo the fault ride-through test safely and successfully.

8.5.3 Preparations for earth fault testing:

- Measure the capacitive current to earth and model overvoltage.
- If necessary, conduct a preliminary earth fault test at reduced voltage to confirm correct operation of relays.

8.6 FAULT RIDE-THROUGH TEST

8.6.1 The fault ride-through test is carried out when the preparatory modelling and tests are complete and provides information on the generator decrement curve and the transient response of the generators which is used to validate or update the model. The validated model can then be further used to confirm correct operation of the protection devices and control systems in many more diverse configurations and failure scenarios by leveraging modelling techniques in lieu of intrusive testing.

8.6.2 Industry experience has recorded that DP vessels have been built with insufficient excitation support. This has only been revealed when the vessel suffered a short circuit fault in the distribution system. The fault was not cleared, the system voltage remained suppressed and under voltage release operated in a non-selective manner with effects exceeding the worst case failure design intent. This has been addressed by various types of excitation system such as current boost systems, auxiliary windings and permanent magnet exciters which are also proven during fault-ride through testing.

8.6.3 The simulated fault is applied as a bolted three phase connection to earth. Options for connection points are available, including:

- On the outgoing way of a feeder circuit breaker not directly associated with DP, perhaps a drilling service transformer or drilling drive transformer.
- On the HV terminals within a suitable transformer enclosure.

8.6.4 Wherever the bolted connection is located it is essential that the entire circuit from that point to the main bus bars is capable of withstanding the maximum short circuit current. It is normal practice for all distribution equipment in HV marine systems to be rated for the full short circuit level all the way from the generator terminals to the power consumers. Where a cable forms part of the test current path it is important that it is suitable for both the magnitude and duration of the short circuit. Where a feeder cable is used it is likely that the time for which this cable is exposed to the fault current will be longer than normal and the cables final temperature rating should be confirmed as adequate.

8.6.5 Attention is drawn to electric stress levels created by sharp points and the need for stress grading in insulation.

8.6.6 Test Procedure:

- The settings on the short circuit protection of the test feeder are changed to ensure it trips after the busties open. In particular, the time delay is extended to be longer than the delay on the bustie but shorter than the generator tripping time.
- The simulated fault is applied by remotely closing the test circuit breaker.
- After a short but defined delay, the overcurrent protection opens the bustie isolating the fault to one redundant machinery group.
- The protection for the generators in the healthy part of the power system resets and the relays do not complete their tripping cycle.
- On the faulty section of the power system the fault is cleared at the test feeder. The fault is isolated and the healthy part of the plant continues without malfunction.

- If necessary, the test feeder timing can be extended past the tripping of the generators on the faulty side to prove they would clear the fault, but this is not strictly necessary to prove fault tolerance for DP purposes and creates uncertainty about the ride through capability of that section.
- The amount by which the delay is extended can be considered a margin of confidence which can be used to demonstrate that the ride through capability is not marginal.

8.6.7 The portfolio of evidence is described in Section 9.2 of this TECHOP and would normally include waveforms for all main busses. In this section, the waveforms are largely associated with the bus to which the fault is applied because these show the complete test cycle from fault application to disconnection.

8.6.8 The power plant is normally tested in its weakest DP configuration in terms of the number of generators connected. Typically, two generators online and all thrusters and other consumers on line as shown in Figure 8-6. This is necessary to ensure any malfunction or lack of voltage dip ride-through can be identified. It may not be necessary to have industrial mission equipment operating such as drilling equipment unless this is of specific interest, but distribution transformers associated with such equipment should be energised as this can influence the response of the power plant to the test (inrush current and voltage overshoot during recovery in particular). It is understood that some classification societies will require all transformers to be connected.

8.6.9 Although the focus of this TECHOP is on station keeping integrity this method of testing provides an opportunity to observe and record the response of industrial consumers to severe power system transients.

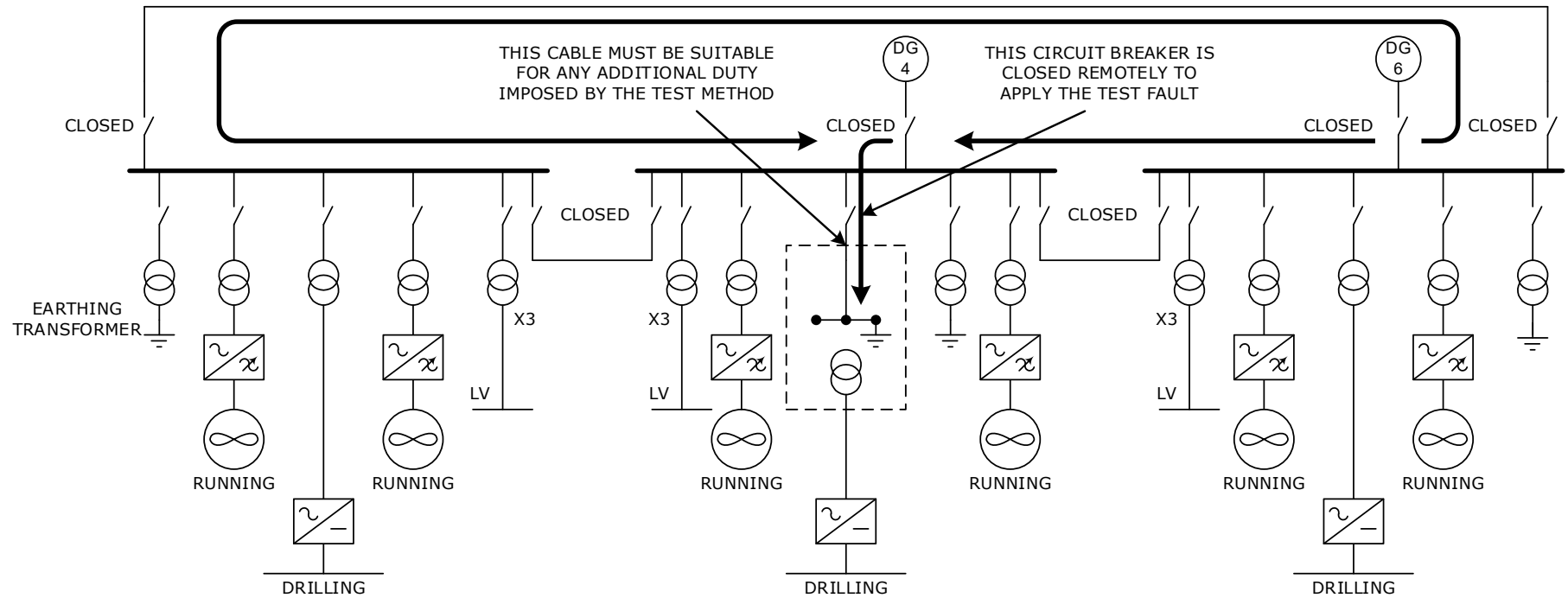

Figure 8-6 Arrangement of Fault Ride-Through Test

Note:

1. The heavy line indicates the main fault current path in this 'ring' system. Fault current also flows from the LV distribution.
2. There are three LV service transformers on each switchboard serving forward, aft and topside systems respectively. Only one is shown for clarity.

- 8.6.10 The example power plant shown is representative of a large MODU. Such vessels have large DP loads and large industrial loads and are amongst the most powerful diesel electric power plants built for commercial marine use. High voltage power systems are nearly universal in this application with 6.6kV and 11kV being the preferred voltages. For a given power rating, the nominal and fault currents reduce as the system voltage is increased.
- 8.6.11 HV power systems are built from a range of type approved components with standard operating voltages and short circuit withstand ratings. It is normal practice to specify a standard rating that is above the maximum calculated fault current by an acceptable margin. There is a standard range of IEC ratings for metal enclosed switchgear based on their short circuit breaking rating. 25kA, 31.5kA and 40kA are typical values. In many cases the switchgear is already over-rated for the actual maximum fault conditions.
- 8.6.12 The example switchboard shown in Figure 8-6 has the ratings given in Table 8-1 below.

Table 8-1 Switchboard Ratings

Voltage (rated)	Current (continuous)	Short circuit breaking rating	Asymmetric breaking rating	Short circuit making rating	Circuit breaker opening time
11kV	2000A	31.5kA	35.4kA	82kA	<65ms (<3.9 cycles at 60Hz)

- 8.6.13 The short circuit making rating of the circuit breakers is related to the peak current which follows when the short circuit occurs. In addition to this, the peak current figure is also used to dimension the mechanical strength of the bus bar restraint system that prevents the bus bars being deformed by the magnetic forces associated with the short circuit current. In this example, the switchboard is rated to handle peak currents of up to 82kA.
- 8.6.14 **Design Margins:** The short circuit calculations performed by the manufacturer show that the actual peak current under worst case conditions is 56kA so the switchboard is already rated at 46% over the expected peak current. Figure 8-7 shows the measured current flowing into the simulated fault. The peak current is of the order of 25kA. This current is measured with two of the six generators connected, all thruster drives operating in auto DP and all service transformers, drilling transformers and drilling drive transformers connected. Thus, the peak test current is only 30% of the switchboard rating. The test current could be reduced further by disconnecting more transformers and motors but the configuration would be less representative and increase the possibility of failing to reveal a hidden failure.
- 8.6.15 Because the force experienced by the bus bars is related to the square of the peak short circuit current the forces during the test are less than 10% of those associated with the switchboards rating.

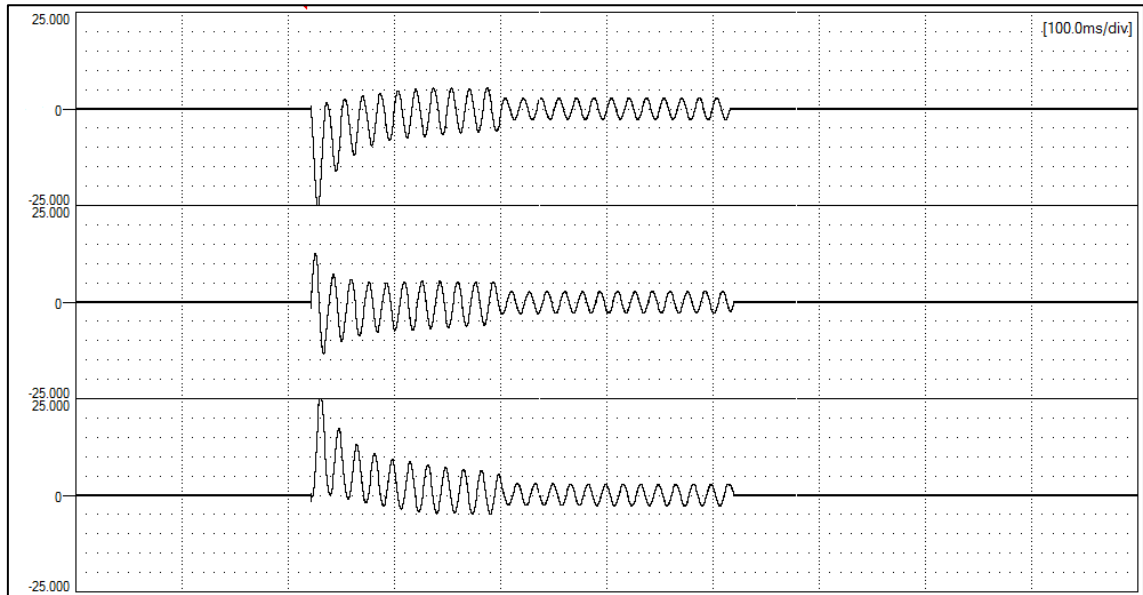

Figure 8-7 Measured Short Circuit Current at Feeder to Test Fault

8.6.16

One of the most important attributes to be proven by the combination of modelling and testing is that all consumers are able to ride-through the voltage transients created by the fault. This attribute is often referred to as 'voltage dip ride-through capability' but should more properly be called 'voltage excursion ride-through'. As Figure 8-8 shows the bus voltage drops to virtually zero during the application of the test fault. When the fault is cleared the bus voltage recovers quickly but overshoots the nominal 11kV value for more than 200ms. This modest, time limited, overvoltage of around 12% is not sufficient to cause malfunction in this case but this must be confirmed in other configurations using the validated mathematical model. The speed of recovery and magnitude of the voltage after the fault are variable and influenced by the design and control strategy of the excitation system (4).

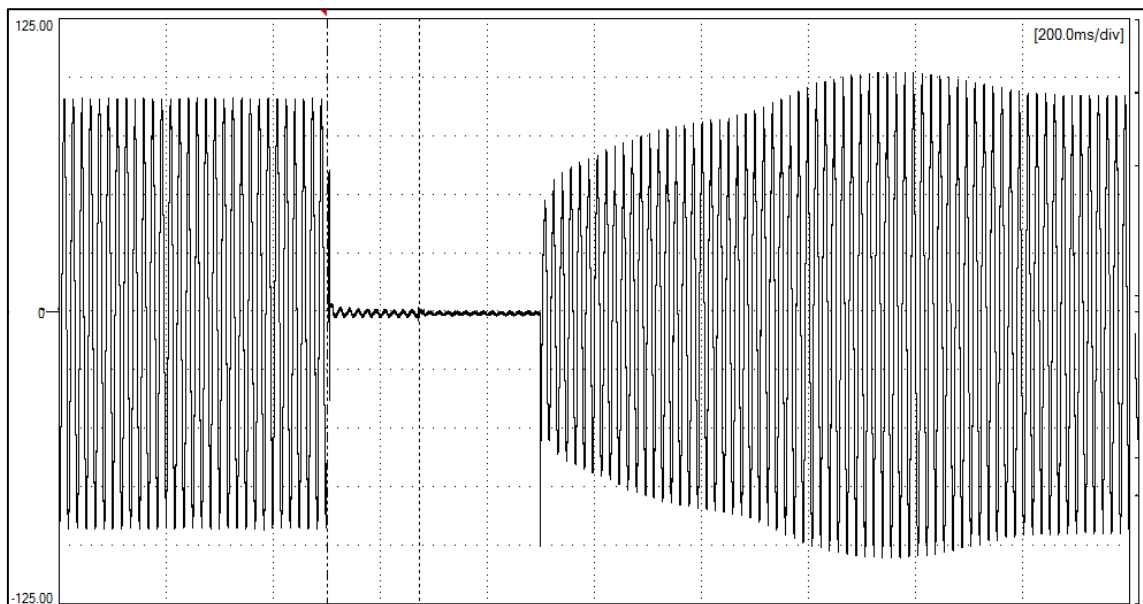

Figure 8-8 Bus Voltage Before, During and After Application of Test Fault

- 8.6.17 Figure 8-9 shows the test fault current, bus voltage and the status of two circuit breakers on the faulty centre switchboard. The upper trace shows the current flowing into the test fault. The second trace shows the status of one of the two circuit breakers that opens to isolate the fault to the centre switchboard. The third trace shows the bus voltage and the last trace shows the status of the feeder circuit breaker used to apply and remove the test fault. At the moment the fault is applied, by remotely closing the drilling feeder circuit breaker, the current contribution of two generators and the transformer / motor contribution from the rest of the plant all flows into the test fault. Approximately 200ms after the fault is applied, the bustie circuit breakers on each end of the switchboard open to isolate the fault and the healthy switchboards (port and starboard) recover without malfunction. The effect of isolating the switchboard can be seen in Trace 1 by a marked reduction in the fault current which is now supplied by one generator. In the case of a real bus bar fault the generator(s) on the faulty switchboard would now trip on overcurrent and de-energise the faulty switchboard but in the case of the fault ride-through test the feeder circuit breaker supplying in the fault removes the fault after approximately 400ms and before this trip occurs. Thus, the bus voltage recovers as can be seen in Trace 3.

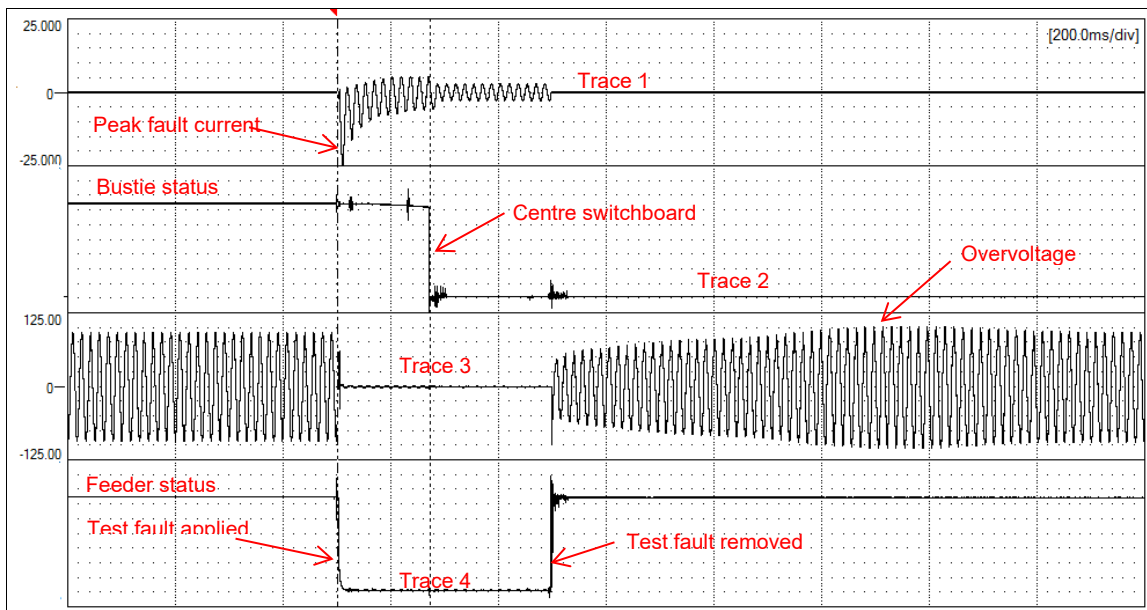

Figure 8-9 Fault Current, Bus Voltage and Status for Bustie Circuit Breaker and Feeder Circuit Breaker

- 8.6.18 Removing the test fault before the tripping time of the last generator supplying the fault allows the ride-through capability of the consumers on the faulty bus to be confirmed. It also confirms that there is a reasonable margin in the ride-through capability as the test fault persists for more than twice the time it takes to isolate the faulty power systems using the bustie circuit breakers. Thus, it can be confirmed that the ride-through capability of the thruster drives, with these particular settings, is not marginal or close to the tripping time of the busties. Proving there are adequate margins is particularly important when there are only a limited number of test opportunities.
- 8.6.19 The load on the switchboard is generally that required for station keeping and can usually be supplied by two generators under sea-trials conditions. The effects of different loading conditions from those of the test conditions can be explored using the post-test validated model.

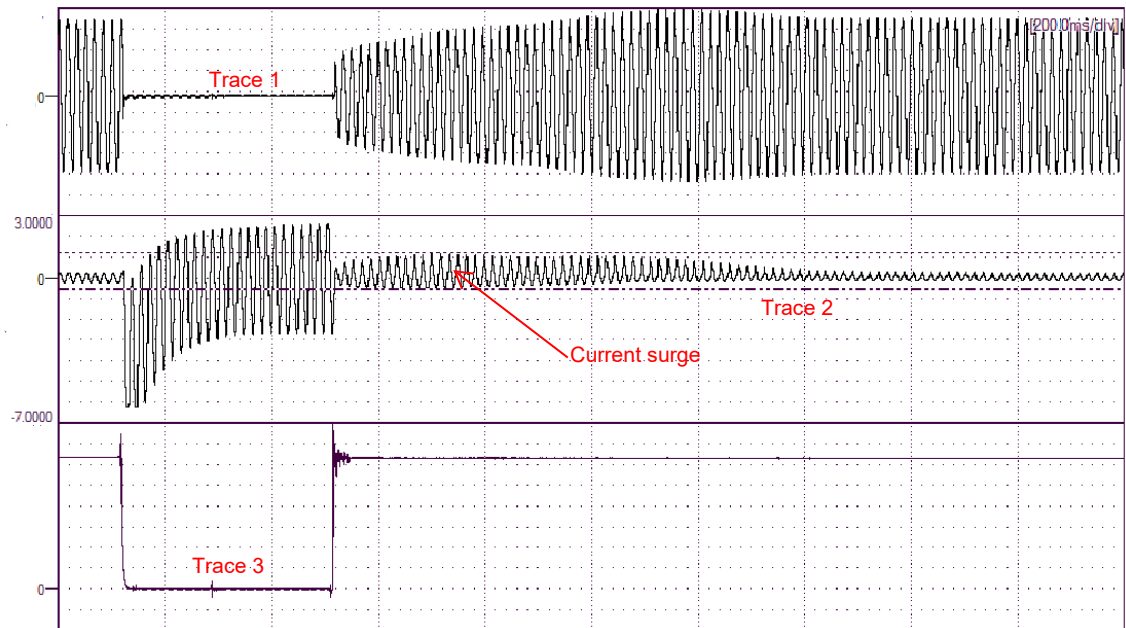

Figure 8-10 Generator Current During Fault and Recovery

- 8.6.20 Trace 1 in Figure 8-10 shows main bus voltage collapsing during the application of the test fault and recovering after it. Trace 3 shows test circuit breaker status. Trace 2 shows the generator current over the same period. The surge in current after the test fault has been removed is associated with re-excitation of thruster, service and drilling transformers. This does not cause tripping of circuit breakers and propulsion power as DP is maintained in this example and the same results can be confirmed by computer simulation in other power plant configurations and fault scenarios.
- 8.6.21 The circuit breaker used to apply the test short circuit in this particular example was rated for a rated a peak current of 82kA and a short-term withstand current of 31.5kArms for 3s. This figure is also the rated short circuit breaking current. The test fault current was, at all times, below this figure and was applied for less than 1s. The time duration associated with the rated short term withstand figure can vary and the circuit breaker specification should be reviewed as part of the preparations.
- 8.6.22 The mechanical nature of the circuit breaker mechanism prevents it opening instantly following a closing operation but even if this were to occur, the test fault current is at all times below the rated short circuit breaking current.
- 8.6.23 The number of switching cycles a circuit breaker can perform at its maximum rated breaking capacity is related to the current it interrupts as shown in Figure 8-11.

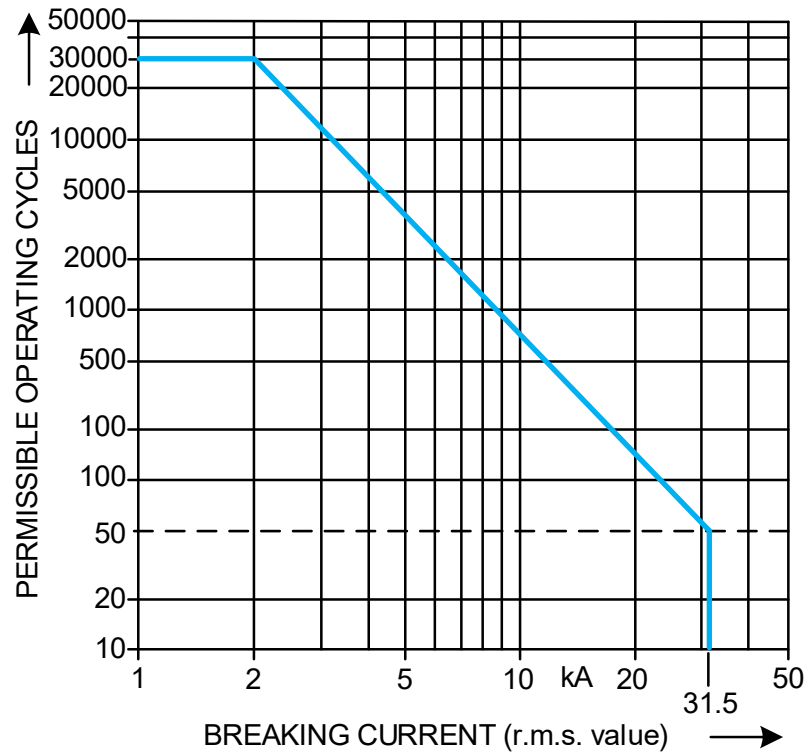

Figure 8-11 Permissible Operating Cycles

- 8.6.24 In standard specification, this example circuit breaker can interrupt its short-term withstand current 50 times without maintenance. The test current at which the drilling feeder circuit breaker actually operates is of the order of 2kA rms. At this level of current, the test circuit breaker is capable of more than 30000 operations before requiring maintenance. The current at the time the bustie clears the fault is higher around 4kA rms in this case equating to 5000 operations before maintenance.
- 8.6.25 Note that not all circuit breakers are capable of this performance and choosing a circuit breaker with the right characteristics would be part of the 'build to test' process. In the case of a vessel in service it would be part of the survey process to confirm the suitability of the switchgear. Reference can be made to IEC 62271-100, *High Voltage Switchgear and Control Gear – part 100' Alternating Current Circuit Breakers* which makes reference to three opening and closing operations. Note that the circuit breaker is only required to interrupt a fraction of its rated current during the fault ride-through test.
- 8.6.26 It is expected that OEM recommendations will be sought and followed prior to executing verification by testing. In service failures and its impacts on suitability of subjecting equipment to testing is to be analysed with appropriate technical support.
- 8.6.27 The discussion in Section 8 relates to one particular case. Suitable calculations and computer simulation by a competent body should be used to confirm that ratings and safety margins are not exceeded in each and every fault ride-through test.

8.6.28 The LV switchgear which forms part of the vessel's power distribution system will contribute to the fault current with the most significant contribution being delivered as motor contribution through the service transformers. This contribution will normally be a small fraction of its rating and this should also be confirmed by calculation. The extent to which this regenerative effect supports contactors and prevents disruption of LV consumers should be determined by modelling and proven by testing but this is only necessary if dual fed consumers or colocation of non DP related equipment forms a common point when the effects of fire and flooding are considered. As the LV switchgear may be provided by a different manufacturer it is important to resolve any contractual issues this raises. In the case of a newbuilding the shipyard would normally be responsible for taking this role.

8.7 EARTH FAULT RIDE-THROUGH TEST

8.7.1 Industry has experienced similar consequences due to earth faults. The test method and equipment described in this TECHOP could be used to validate earth fault ride through capability. The purpose of the earth fault test is to confirm the correct operations of the primary earth fault protection and ensure that it is coordinated in a manner that supports the worst case failure design intent for the DP system. It also confirms that there is no undesirable failure effect associated with the short term redistribution of the line to earth voltages which occur during an earth fault.

8.7.2 The earth fault test is carried out in much the same way as the fault ride-through test but in the case of the earth fault test only one of the three phases is connected to the ship's hull as shown in Figure 8-12. The test fault is applied for just longer than the earth fault protection on the switchboards takes to isolate the fault to the centre switchboard.

8.7.3 Earth fault currents are much smaller than short circuit fault currents and typically of the order of a few hundred amps or less. In some HV power system designs, the earth fault currents are so low that earth faults are not automatically isolated. However, in most large marine power systems, automatic protection based on sensitive differential protection using core balance CTs is fitted. It is established practice to specify HV cable such that the phase to earth insulation is rated for the line voltage but some rules may allow for other arrangements if automatic isolation is provided. Where practice is to specify the line voltage for cable earth insulation purpose an 11kV marine distribution system would be built using 8.5/15kVrms cable. This is in line with the 'built to be tested' philosophy espoused by DP class notations requiring this type of testing. Figure 8-13 shows the three main bus voltages before during and after the application of the fault.

8.7.4 As expected, the faulted line to earth voltages go to zero and the two healthy lines to earth voltages increase. In this case from the peak voltage of around 9kV to 15.5kV. This represents a rms voltage of around 11kV thus the line to earth voltages rise to the line-to-line voltage as expected.

8.7.5 Figure 8-13 shows no significant overvoltage beyond that expected, thus the cabling is not overstressed and the test earth fault is isolated to the faulty switchboard and eventually disconnected.

8.7.6 Figure 8-14 shows the measured earth fault current, bustie circuit breaker status and main bus voltage before, during and after application of the test earth fault. In Trace 1 the test earth fault current is around 40A rms when the test fault is applied. The bustie circuit breakers take just over a second to isolate the earth fault to the centre switchboard. At which point the rms earth fault current drops to 13A. The test earth fault is finally removed by the drilling feeder.

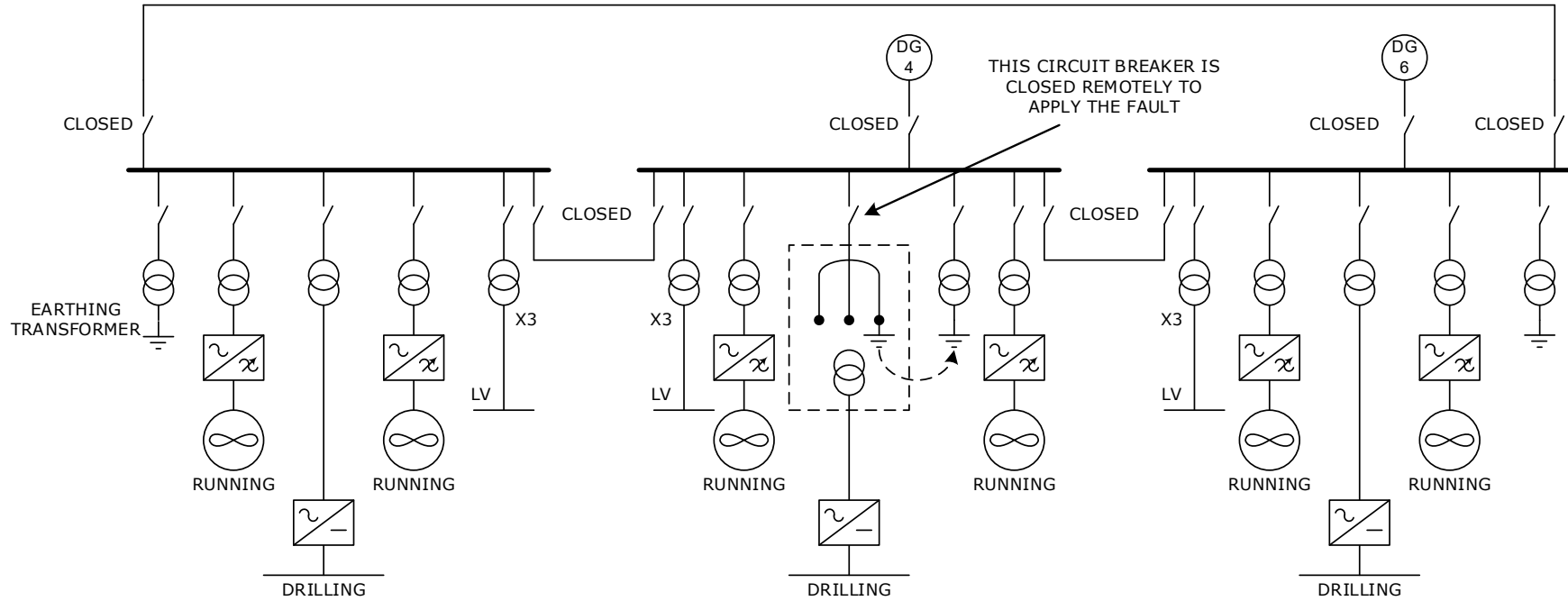

Figure 8-12 Arrangement for Earth Fault Test

Note: There are three LV service transformers on each switchboard serving forward, aft and topside systems respectively. Only one is shown on each switchboard for clarity.

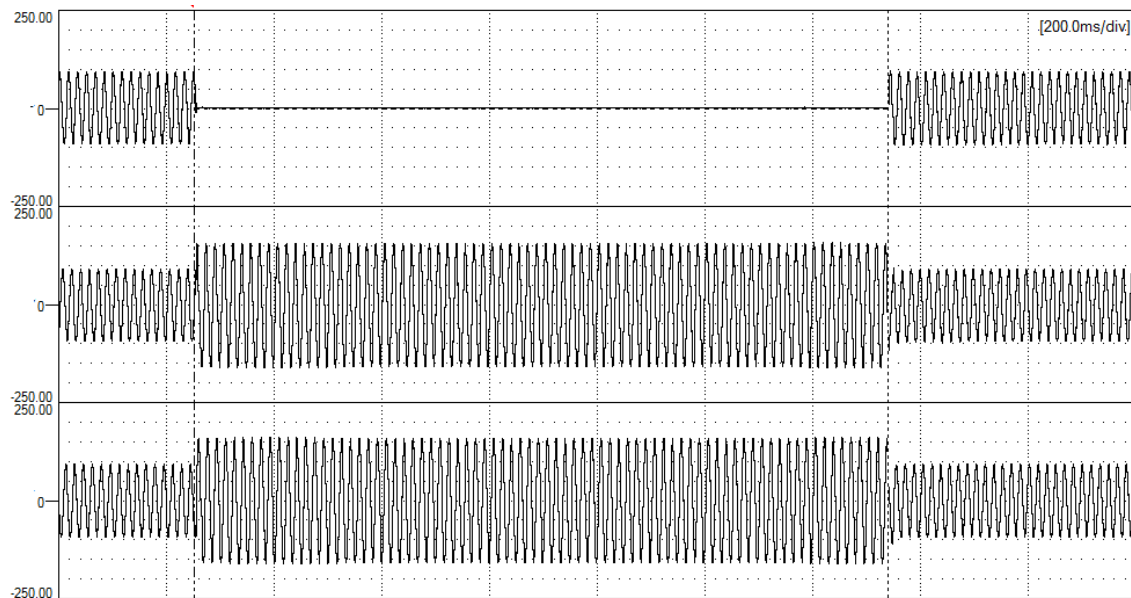

Figure 8-13 Bus Voltages Before, During and After Application of Test Earth Fault

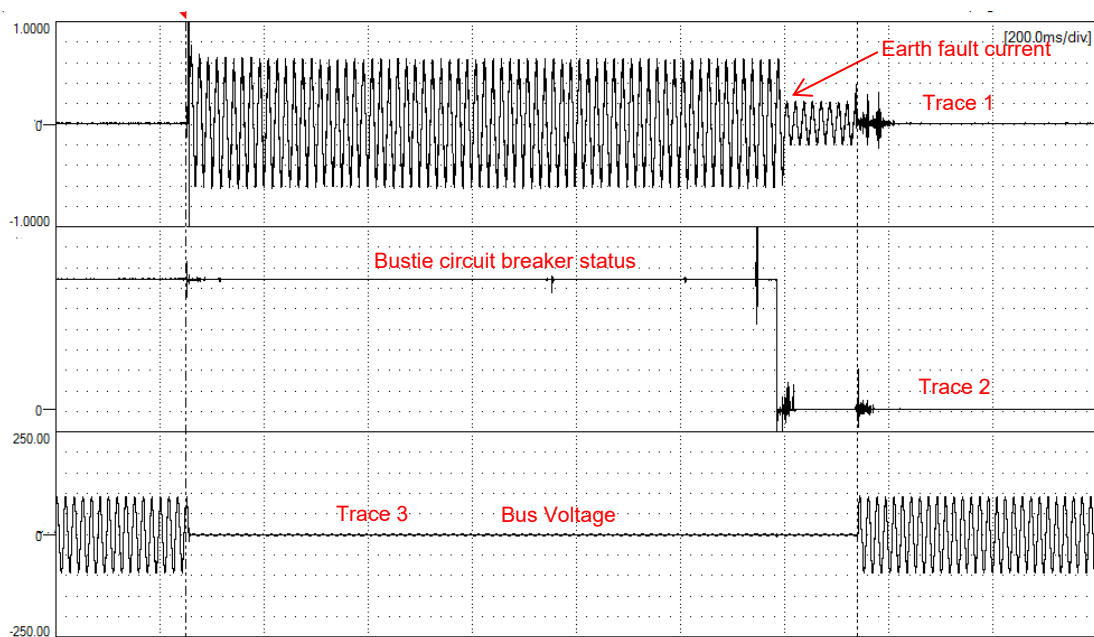

Figure 8-14 Earth Fault Current, Bustie Status and Bus Voltage

8.8 THRUSTER DRIVES

8.8.1

The fault ride-through and earth fault tests are carried out with the vessel operating on full auto DP with all thrusters online. Thruster variable speed drives are potentially one of the most sensitive consumers. Although almost all modern drives specified for use with thrusters have voltage dip ride-through capability, this depends on the correct setting of various protection functions within the drive control system.

- 8.8.2 Carrying out pre-testing of these settings and protective functions can increase confidence in a successful fault ride-through test result. Ride-through capability may also depend on the correct operation of features such as dynamic braking resistors etc.
- 8.8.3 Many modern variable speed drives provide a data logging function which can be used to record important waveforms such as:
- Inverter bridge firing pulses.
 - DC link voltage.
 - Auxiliary control voltage.
 - Braking resistor current.
 - Speed / Torque command and feedback.
- 8.8.4 In addition to observing that the thruster continues to operate without malfunction, these recordings can be analysed to confirm the correct response of the drive to the conditions created during and after the application of the test fault. In particular, where voltage excursions are experienced by the DC link, the recordings can confirm the margin between ride-through and protection trip which can be further validated by computer simulation.
- 8.8.5 The satisfactory failure response of a thruster is a matter for individual classification societies. A momentary pause in thrust followed by rapid restoration with no circuit breaker opening or interruption of the DP ready signals is generally acceptable. Thruster feeder circuit breaker trip followed by reclose and rapid reconnection of thrusters has been accepted under some circumstances where the drive functions were sustained by internal energy storage. Stop and restart of thrusters is generally not accepted.

8.9 MEASUREMENT POINTS

- 8.9.1 In the case of newbuild vessels, or those undergoing major conversion work involving the switchboards, it makes sense to include all the test points for carrying out this type of testing during the construction phase. Easy access to the secondary (low voltage) sides of switchboard Voltage Transformers (VTs) and Current Transformers (CTs) can be from a dedicated and safe test cubicle. Industry standard test equipment points such as Bayonet Neill–Concelman or Baby N Connector (BNC) connectors for voltage probes and Hall-effect or clip-on CTs for measuring current can be provided. Consideration should also be given to providing ready access to circuit breaker status signals for busties, generators circuit breakers and test feeders to reduce the risk of introducing additional faults in the test phase.
- 8.9.2 Modern protection devices are also able to provide a wealth of useful information. This is typically made available on some form of industry standard serial bus. This information is invaluable for troubleshooting routine maintenance issues but can be included in the information sources collected after fault ride-through testing.
- 8.9.3 Signal sources that could be instrumented or used to collect data include:
- Generator VTs and protection & measuring CTs.
 - Bus VTs and protection & measuring CTs.
 - Feeder measuring CTs.
 - Serial links from protection relays.
 - Serial links from governors and AVRs.
 - Serial links from thruster drives.
- 8.9.4 Different types of CTs used for protection and measurement have different ranges and accuracies.

- 8.9.5 Vessel management systems for larger DP vessel typically have extensive data logging capabilities. The sampling rate is typically of the order of 1Hz with 10Hz available for power systems monitoring. Although these sampling rates are not fast enough for waveform analysis, they are useful for the recording of general power plant response such as changeover of pumps or machinery tripping and so on.
- 8.9.6 When selecting a suitable data acquisition unit or oscilloscope for waveform recording from the large number of suppliers it is important to choose a unit (two such units may be necessary depending on the number of channels) with the right characteristics. Protection responses take place from tens of milliseconds to seconds and features of duration of less than one cycle may be of interest. In the analysis of power systems, a large memory may be more useful than an extremely high sampling rate. Those responsible for the mathematical modelling work may have specific requirements in terms of data format for importing to software packages. The waveforms presented in this report were originally sampled at an interval of 2 μ s over 10s with a memory size of 5M data points.
- 8.9.7 If more than one data acquisition system is required it may be necessary to time synchronise them and some units have facilities for this purpose. In addition to this it is useful to ensure all other data loggers and history stations are correctly time synchronised in so far as it is possible to do so. A facility to synchronise with Global Positioning System (GPS) time may be available.
- 8.9.8 Means to initiate recording remotely and safely should be considered in the process of choosing data acquisition systems. When recording is initiated by a change in circuit breaker status signal the ability to record data for a defined period prior to initiation is also useful.
- 8.9.9 Attention is drawn to the need for all test gear to be designed with adequate safety margins for the voltages and currents to which it and its operator may be exposed.

8.10 INSPECTIONS AFTER TEST

- 8.10.1 After the test is completed, all test equipment should be removed and any temporary connections points restored and made safe. If the vessel was designed with this type of testing in mind then this will be a simple matter of disconnecting the oscilloscope probes etc. from the test points provided. Keeping a log of such connections may help to prevent inadvertently leaving something connected.
- 8.10.2 A careful check should also be made to ensure any protection settings changed are returned to the correct values as per the approved protection coordination study. In the unfortunate case that the protection coordination has been proved to be incorrect by the test, any remedial changes should be subject to a suitable and sufficient management of change process.
- 8.10.3 In the test method described in this TECHOP only one setting needs to be changed and that is the overcurrent setting on the feeder to the drilling transformer. Omitting to return this back to its correct setting does not actually invalidate the redundancy concept because the failure effects do not exceed the loss of more than one redundant equipment groups but that effect is unnecessarily severe.
- 8.10.4 It is not necessary to defeat any safety interlocks in the test method described.
- 8.10.5 Each manufacturer will have their own internal procedures for carrying out inspection on the equipment subjected to the test but it is understood that if only one or two tests have been carried out then only a general inspection is required.

- 8.10.6 A general inspection of the generators used for testing could include visual inspection of:
- End winding.
 - Auxiliary components, AVR's, CT's etc.
 - Cable terminations.

8.11 REQUIRED PROTECTIONS AND PRECAUTIONS

8.11.1 The safety precautions to be implemented are those associated with commissioning a high voltage power plant. The most effective safety measure is to remove personnel from the danger areas. It is part of the 'build to test' philosophy to ensure that the vessel design facilitates this requirement during testing. Special emphasis can be placed on fault ride-through testing as follows:

- The preparatory work should be structured and designed to minimise the need for personnel of any kind to be in the vicinity of parts of the HV distribution system while it is energised. In particular, it should not be necessary to have engineers or other personnel in the HV switchboard rooms while the switchboard is energised.
- A suitable and sufficient risk assessment of the test procedure and associated activities should be carried out. 8.12.
- Effective permit to work procedures should be in operation.
- The switchboard should be de-energised and isolated remotely and confirmed earthed down while any work is carried out.
- Effective Lock Out & Tag Out procedures are to be implemented.
- A plan to control the location and activities of personnel including an evacuation plan should be prepared and rehearsed.
- Personnel should be familiar with the operation and use of rescue equipment in the HV switchboard room.
- Medical personnel should be familiar with treating the effects of electric shock and associated burns etc.
- Effective means of communication should be established between all parties involved or affected by testing.
- Precautions against the effects of loss of position should be taken, as for any DP system undergoing FMEA proving trials testing.
- Closed-circuit television (CCTV) facilities should be established at key test locations.
- Fire detection facilities should be confirmed operational.
- The operation of mobile and fixed fire-fighting facilities should be confirmed.
- Be aware of the risks associated with flashovers on HV power systems.

8.11.2 Several layers of protection would have to fail to prevent the fault being cleared at some point in the system. However, it may be prudent to stand by the remote emergency stops / ESD for the plant while the test is conducted.

8.12 RISK ASSESSMENT

8.12.1 A suitable and sufficient risk assessment should be conducted with a team competent to understand the nature of the risks including:

- Subject matter experts for HV power systems.
- All parties involved in the testing.
- Representatives from vessel operations team, Master, OIM etc.

- 8.12.2 Risk assessment procedures are widely used in the Oil & Gas industry and a typical risk assessment from would present the following information:
- Activity.
 - Hazard.
 - Risk evaluation before control measures (H/M/L).
 - Control measures required.
 - Risk evaluation after control measures (H/M/L).
- 8.12.3 In the process of considering the hazards that may occur, it may be useful to consider some of the potential scenarios or failure conditions which could lead to hazardous events which may include but are not limited to the following:
- Mechanical failure of a generator including coupling failure.
 - Test circuit breaker fails to open.
 - Main bus bar bracing fails.
 - Generator interaction / oscillation.
 - Corona develops on the shorting bar used for testing.
 - The shorting bar melts.
 - Consumers online during test suffer electrical fault.
 - Equipment under test not available to vessel for station keeping.
 - Loss of position / heading
 - Protection system fails to operate as expected.
 - Test equipment fails.
 - Confusion as to equipment status during testing.
- 8.12.4 The consequences of each event above should be identified along with any other possible risks identified by the risk assessment process. In each case the vessel and test specific mitigation measures required to reduce the risk to an acceptable level should be determined and documented.
- 8.12.5 It is anticipated that such a risk assessment should form part of a documented submittal plan to the classification society for the vessel as part of the trials plan even if it is not subject to approval by them.

9 OBJECTIVES OF POWER PLANT MODEL AND VALIDATION

9.1 ANALYSIS AND INITIAL SIMULATION WORK

9.1.1 A combination of testing and computer simulation of the power system's response is considered to provide the highest level of confidence in the fault tolerance of the DP system given the practical constraints on the number of tests that can be conducted and the time taken to carry them out. Testing has the advantage of revealing potential hidden failures and design deviations. Modelling allows a much greater number of configurations and fault scenarios to be considered.

9.1.2 The objectives of the modelling work are:

- To reproduce the test results and other known conditions to an acceptable degree of accuracy to provide confidence in other predictions.
- To model a range of generator, thruster, transformer and industrial consumer configurations and fault scenarios with a view to identifying the worst case.
- To model a full range of fault types. Note: the sensitivity to the duration of the fault is to be validated.
- To demonstrate that there are adequate margins between predicted power system response and the action of protective functions that could cause the redundancy concept to be defeated.

9.1.3 The following are the reasons why it is acceptable to use the results of one test to validate the model:

- The validation is carried out with the plant in its weakest condition and so validates a point of concern where the margins for over current selectivity are at their smallest.
- Power plants are generally more robust with more generators connected.
- Carrying out tests at higher currents could erode the generous margins that reduce the risk of damage.
- The range over which the model must scale the results from the test current is relatively low. For example 1:3.
- It has proved sufficient historically and is acceptable to the classifications societies.

9.1.4 The objectives of Real Time Digital Simulation (RTDS) and Hardware-In-the Loop (HIL) testing is to confirm the correct operation of protective functions upon which the DP system's fault tolerance depends across the full range of fault conditions the power plant may experience. RTDS allows the actual protection relays and variable speed drive controllers to be exposed to representative fault conditions and for the action of the protection relays to be fed back into the simulator to close the loop. Depending on the type of protection relays, the interface can be digital or analogue. In the case of analogue relays, software models of the CTs and VTs are used to create the signals to be fed to the protection devices. Digital convertors on I/O interfaces are used to supply the relays with the secondary side current and voltage signal they expect to receive. Protection systems complying with the relevant parts of IEC 61850 can use direct digital signalling using the Generic Object Oriented Substation Events (GOOSE) over fibre-optic Ethernet connection to the relay.

9.1.5 Power system manufacturers contacted as part of this study indicated their intention to use, or support the use of, RTDS or equivalent facilities to test the following elements:

- Protection relays.
- Specialist generator protection for parallel operation (fuel and excitation control faults).
- The protective functions within thruster variable speed drives.

- 9.1.6 The possibility exists to extend this type of testing to other control systems such as governors and AVRs.
- 9.1.7 Power system manufacturers questioned on the subject of arcing faults confirmed that although the random and chaotic nature of arcs is not reproduced in simulations there are no aspects of an arcing fault that are not adequately addressed by covering a range of other fault conditions.
- 9.1.8 Some classification societies may require arc faults to be listed amongst the fault types to be considered. Industry experience reports that it is possible to reproduce effects approximating arcing faults using suitable load banks to create faults with substantial voltages. Values of around 50% can be expected on LV systems and somewhat higher voltages for arcing faults in HV systems. The nature of the generator current is of particular interest in such faults.

9.2 PRESENTATION OF RESULTS

- 9.2.1 Each classification society may have its own specific requirements but in general it is expected that the presentation of the results would be in the form of a formal report documenting the combined results of modelling and testing in an integrated manner which demonstrates the ability of the power system to successfully ride-through the effects of a short circuit fault and earth fault. Suggested contents could include:

1. **Introduction**

- a. Vessel, DP system and power systems description.
- b. Redundancy design intent and worst case failure design intent.
- c. Power plant configurations and fault types to be modelled and tested.

2. **Applicable rules, standards and class notation.**

3. **Risk assessment**

4. **Test methodology** – Description of test method with supporting sketches.

5. **Discussion of simulation methodology** – Simulation package, RTDS, HIL etc. Discussion of any assumptions made in modelling of configurations which were not tested. Means by which the worst case conditions were identified.

6. **Results**

- a. Combined results of modelling and tests showing that the model is able to accurately predict the dynamic response of the power system.
- b. Comparison of measured and modelled waveforms.
- c. Comparison with the results of static studies such as short circuit calculations.
- d. Results of RTDS or HIL demonstrating that actual protection and control systems respond correctly to worst case conditions.
- e. Presentation of worst case conditions and confirmation that the severity of the failure effect does not exceed the DP system's worst case failure design intent.

7. **Conclusions** - On compliance with the applicable rules and standards.

- 9.2.2 Simulation package qualification process: At present, the only qualification process applied is to demonstrate the ability of the simulation package to accurately recreate the measured results. Classification society rules often make reference to particular international standards such as those of the IEC when indicating acceptable calculation methods etc. Early engagement with the appropriate classifications society is advised in the absence of such guidance on acceptable simulation packages.

10 ALTERNATIVE FORMS OF TESTING

10.1 THE NEED FOR ALTERNATIVE METHODS

- 10.1.1 The test methods described in this TECHOP are not suitable for all types of DP power plant. There will be a need to develop suitable methods, specific to the power plant design, to demonstrate fault ride through capability if it is intended to conduct critical DP operations with their diesel electric power plants configured as a common power system.
- 10.1.2 Classification societies are generally receptive to methods not covered by their rules, which provide a similar level of confidence in station keeping integrity. Seeking concurrence from the classification society on acceptance of an alternative method is essential. Concurrence of other stakeholders should also be obtained if deemed necessary.
- 10.1.3 Methods such as RTDS and voltage dip testing as described in this TECHOP should be leveraged, in alternate processes as complementary methods.

10.2 LOW VOLTAGE POWER SYSTEMS

- 10.2.1 A very significant part of the DP fleet has low voltage power systems such as 690V or 480V power generation and this is particularly true of the platform supply and light construction vessel fleet. There is a consensus amongst power system manufacturers contacted as part of this study that it is impractical to prove the fault ride-through capability of low voltage power systems in exactly the same way as their high voltage counterparts. This is largely because the fault currents and forces in LV power systems of even modest capacity are much larger and Air Circuit Breakers (ACBs) used in LV switchboards are sometimes rated for only a single high current interruption after which they require overhaul. Switchboards rated for 100kA are common in LV plant in contrast to the typical rating of 31.5kA for HV systems.
- 10.2.2 Some LV power systems are specifically designed to reduce the fault current to low levels and may be suitable for short circuit testing, such as those that use phase shifting transformers between bus sections. Consultation with the manufacturers of such systems would be required to confirm this.
- 10.2.3 Some shipyards are carrying out fault ride through testing by applying a short circuit on the distribution level that supplies the marine auxiliary systems where this is provided by way of a service transformer. For example, on the 480V level of DP class 2 vessels where the main power generation level is 690V. This does at least confirm the ride through capabilities of the essential pumps and other equipment supplied at this level. Calculations are done to confirm that the fault currents at this level are well within the rating of the switchgear etc.
- 10.2.4 Many conventional LV designs, particularly platform supply vessels with all-electric drives, already operate with their busties open specifically because the fault current is too high when all generators are connected. Vessels with this configuration restriction typically carry out critical DP operations with all generators connected and therefore with busties open.
- 10.2.5 Emerging LV propulsion technologies such as dc distribution schemes are being subjected to short circuit testing in field trials. The significant advantage of these technologies is the possibility to control fault currents using power electronic devices and not circuit breakers.

- 10.2.6 Methods for testing LV systems that could be investigated or developed include:
- Limiting the fault current by suitable inductive reactance.
 - Cycling circuit breakers under automatic control to produce a voltage dip.
 - Modulating the AVRs to create a voltage dip (this is possible with modern digital AVRs).
 - Exciting the main bus by way of a variable speed drive and modulating its output
 - RTDS and voltage dip ride through testing in combination with complementary processes discussed in 10.1.
 - Connecting a load with significant inrush current characteristics or several in quick succession to create a voltage dip.
- 10.2.7 At this time there is no well-established method for proving equivalent integrity in LV power systems that provides the same level of confidence as that specified for HV systems.

10.3 VESSELS IN SERVICE

- 10.3.1 No vessel owner should feel compelled or under pressure to carry out fault ride-through testing if they feel in any way uncomfortable or uncertain about the safety of the process. However, failure to ensure adequate fault tolerance also carries risks and it is for this reason that MTS guidance promotes the concept of CAM and TAM and the 'build to test' philosophy.
- 10.3.2 At the time of publishing this TECHOP only a relatively small number of vessels have been built to the rules for notations requiring this degree of analysis and testing. These vessels are built for owners who wish to have a very high degree of station keeping integrity when operating with bustie closed. Compliance with the requirements of these notations allows the owners of these vessels to make a case for carrying out critical DP operations with the power plant configured as a common power system when there is a need to do so.
- 10.3.3 Thus, the vast majority of vessels in service comply with earlier rules. What options are available for these vessels?
- Upgrade to the new DP notations.
 - Seek stakeholder approval for alternative testing and modelling.
 - Operate the power plant with busties open.
- 10.3.4 The practical implications of each choice are:
- Upgrading to the new notations could be costly and time consuming but work equivalent to this is routinely carried out by some vessel owners at dry dockings and special periodic surveys. This is likely to be most attractive to vessel owners who carry out critical activities for a large percentage of their operating time.
 - Seek stakeholder approval for alternative methods. Experience suggests that of all the power system attributes to be proven it is the lack of voltage dip ride-through capability that is the most significant. Proving this by any form of testing that creates a representative voltage dip is worthwhile (see Section 0 for suitable methods).
 - Operate the vessel power plant as two or more independent power systems. Many DP vessels are designed and built with this as the preferred configuration. Often stakeholders may stipulate (sometimes contractually) their requirements to operate power plants in an open bus configuration. Vessels which do experience restrictions on operating capacity with busties open often find that this can be managed by operational procedures and concurrence of stakeholders.

- 10.3.5 The concepts of CAM and TAM are being used to manage exposure to loss of position incidents. The choice is based on the following:
- Industrial mission of the vessel.
 - Duration of the activity / exposure.
 - Stakeholder stipulations.
- 10.3.6 Where the above considerations conclude that the vessel is to be operated with its power plant configured as two or more separate systems the need of verification and testing of fault ride through capability as described in this TECHOP should be assessed.
- 10.3.7 The power plants of DP vessels in service may contain equipment that has been modified or repaired and is no longer correctly described by the original manufacturers' specification or name plate data. The characteristics of any plant subject to testing should be verified. Some vessel owners considering testing vessels in service have engaged the services of the major power system vendors to carry out a pre-test survey of the power plant and advise on the suitability of the plant for testing. Amongst many other items to be checked are the integrity of bus-work and the security of cable restraints. Particularly, those in the test current path. This type of pre-survey is considered to be essential.
- 10.3.8 On older assets there may be a need to evaluate the risk of damage to each component from testing and the implications of any damage to equipment, particularly if it is difficult to obtain spares or the equipment is considered obsolete.
- 10.3.9 Periodic testing requirements are determined by classification societies and statutory bodies.
- 10.3.10 In the case of sister vessels, it seems logical to test each vessel but modelling work could be common if settings and power system design are identical.
- 10.3.11 Some vessel owners have expressed a desire to do some type of testing annually to confirm that settings have not changed or that hidden failures of ride-through capability have not developed. It is not practical to do a high current test on an annual basis. Tests that create a voltage dip using an impedance, cycling circuit breakers or by modulating the AVR's / excitation system are practical and may provide a useful level of confidence.
- 10.3.12 Frequency of testing should be a function of:
- Classification / statutory body requirements.
 - Changes in equipment that necessitates validation by testing.
 - Conditions leading to a need to rebuild / re-demonstrate confidence in integrity of station keeping equipment.

11 CONCLUSIONS AND SUGGESTED IMPLEMENTATION STRATEGY

11.1 GENERAL CONCLUSIONS

11.1.1 The following conclusions were arrived at in the process of compiling this TECHOP:

1. There is a case for action. Unless they are properly designed and tested, diesel electric DP vessels operating with their busties closed are vulnerable to a range of failure modes to which vessels operating with busties open are not. Thus, vessels operating with busties closed need to undertake activities to demonstrate and build confidence that the design is properly analysed and tested to address these additional failure modes to demonstrate equal station keeping integrity.
2. This TECHOP describes a comprehensive process (HEMP activities, computer modelling, equipment assessments etc.) verified by testing that should satisfy requirements for demonstrating fault ride-through capability of HV power plants commonly found on DP MODUs if operated in a closed bus configuration.
3. Fault ride-through testing can be carried out safely on HV power plant with acceptably low risk of equipment damage or personnel injury when properly planned and executed.
4. An opportunity for improvement has been identified to incorporate language in electrical construction standards for the power generation and distribution equipment of DP vessels to design equipment in a manner that ensures lifespan expectancy is not reduced by testing requirements.
5. Further work is required to establish a means of proving equal integrity for LV power systems operating with busties closed.
6. Further work is required to establish a means of proving equal integrity for those power plants determined to be unsuitable for testing by the means described in this TECHOP.
7. Nothing in this TECHOP is intended to exclude alternative methods of proving fault ride-through capability.
8. Innovations in power plant design and protection systems may render obsolete the methods described in this TECHOP but consideration of these is outwith the scope of this TECHOP.
9. Fault ride through testing is not required for vessels that conduct critical operations with their busties open which have no fault propagation paths in this configuration.
10. Vessels that may operate with their busties closed in Task Appropriate Mode may still require some form of proof of ride through capability which is commensurate with the consequences of loss of position in TAM to meet the expectations of stakeholders.
11. In the case of newbuildings, the build to test philosophy should ensure the equipment is well provided with connection points for test equipment and suitable logging facilities.

11.2 SUGGESTED IMPLEMENTATION STRATEGY

11.2.1 DP industry guidance (IMCA, MTS & USCG) recommends carrying out critical DP activities in a DP system configuration which offers the highest station keeping integrity. What constitutes a critical activity is beyond the scope of this TECHOP and further guidance can be found in TECHOP (O-03 - Rev1 - Jan21) DEFINING CRITICAL OPERATIONS REQUIRING SELECTION OF CRITICAL ACTIVITY MODE.

- 11.2.2 This TECHOP is intended to provide information on one particular method of demonstrating the fault ride through capability of HV power plants usually found in DP MODUs and larger construction vessels. In particular, those vessels designed to operate with their power plant configured as a common power system. The guidance may be applied to new vessels and vessels in service. Note: all stakeholder expectations should be identified and class rule requirements supplemented as necessary.
1. Owners with the intention to build new DP vessels should build to those classification society rules for DP notations requiring proof of fault ride-through capability if they foresee a need to carry out critical DP operations with the busties closed.
 2. Operators of vessels already in service which were built to rules that did not require the same level of proof of fault ride-through capability, who foresee a need to carry out critical activities with busties closed should consider:
 - a. Upgrading the vessel to the new notations.
 - b. Subject the vessel to an equivalent survey, analysis and test program and have this process and configuration documented in a class approved DP system FMEA.
 - c. The need to positively validate the characteristics of equipment subject to repair or modification. Particularly where such work was not carried out by the OEM.
 3. DP vessel owners who foresee a need to operate with busties closed in CAM should be aware that reliance upon protective functions adds to the DP system's periodic test and verification burden.
 4. DP vessel owners who do not foresee a need to operate with busties closed in CAM configuration, but do operate with closed busties in TAM, should consider carrying out RTDS, a voltage dip ride-through test or optionally consider a fault ride-through test subject to a positive suitability survey.

12 REFERENCES

1. IMCA M181, 'Analysis of station keeping incident data 1994 to 2003', Jan 2006.
2. Smeets R.P.P. Leufkens P.P, Te Paske L. H., Fogelberg, 'Thirteen Years' Test Experience with Short Circuit Withstand Capability of Large Power Transformers', Cigre, 6th Southern Africa Regional Conference.
3. Imming, Martijn, and Herrie Engbersen. "Fixed or Withdrawable Switchgear— Withdrawable Switchgear, Past or Future?" Petroleum and Chemical Industry Conference Europe Conference Proceedings (PCIC EUROPE), 2011. IEEE, 2011.
4. Radan D, and Settemsdal S, 'DP3 Class Power System Solutions for Dynamically Positioned Vessels'. MTS Dynamic positioning conference, October 9-10, 2012, Houston.